



Hands-On Guide

to LeCroy

Color

Digital Oscilloscopes

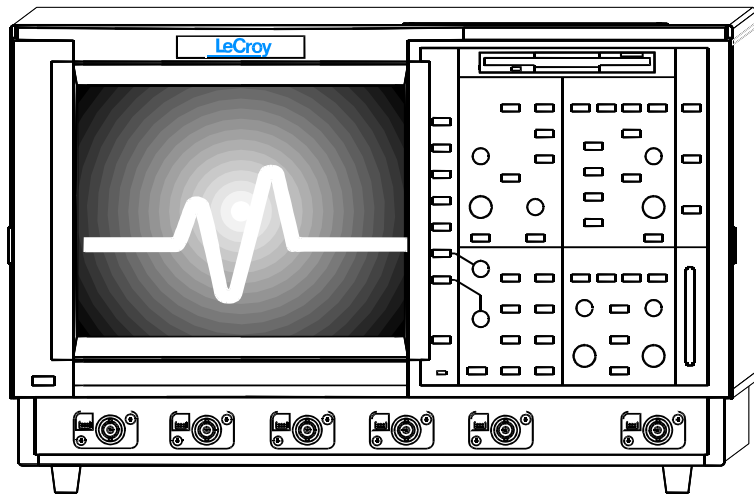

Revision C — April 1998





LeCroy

LeCroy Corporation

700 Chestnut Ridge Road
Chestnut Ridge, NY 10977-6499
Tel: (914) 578 6020, Fax: (914) 578 5985

LeCroy SA

2, rue du Pré-de-la-Fontaine
1217 Meyrin 1/Geneva, Switzerland
Tel: (41) 22 719 21 11, Fax: (41) 22 782 39 15

Internet: www.lecroy.com

Copyright © April 1998, LeCroy. All rights reserved. Information in this publication supersedes all earlier versions. Specifications subject to change.

LeCroy, ProBus and SMART Trigger are registered trademarks of LeCroy Corporation. Centronics is a registered trademark of Data Computer Corp. Epson is a registered trademark of Epson America Inc. I²C is a trademark of Philips. MathCad is a registered trademark of MATHSOFT Inc. MATLAB is a registered trademark of The MathWorks, Inc. Microsoft, MS and Microsoft Access are registered trademarks, and Windows and NT trademarks, of Microsoft Corporation. PowerPC is a registered trademark of IBM Microelectronics. DeskJet, ThinkJet, QuietJet, LaserJet, PaintJet, HP 7470 and HP 7550 are registered trademarks of Hewlett-Packard Company..

Manufactured under
an ISO 9000
Registered
Quality Management
System
Visit www.lecroy.com
to view the certificate.



This electronic product is subject to disposal and recycling regulations that vary by country and region. Many countries prohibit the disposal of waste electronic equipment in standard waste receptacles. For more information about proper disposal and recycling of your LeCroy product, please visit www.lecroy.com/recycle.





Foreword — About this Guide vii

PART 1 All About the DSO *A broad overview of the Digital Storage Oscilloscope, zooming on LeCroy Color DSOs.*

Primary Specifications

Basic Elements 1-2
Bandwidth..... 1-3
Sample Rate 1-4
Memory Length 1-4

Signal Capture

Acquisition Technique 1-5
Analog-Digital Conversion 1-6
Number of Channels 1-6
Triggering 1-6

Signal Viewing 1-7

Measuring

Pulse Parameters 1-8
Waveform Math 1-8

Signal Analysis

Time Domain 1-9
Frequency Domain 1-9
Statistical Domain 1-9

Documentation

Removable Hard Disk Drive (HDD) 1-10
Interfaces..... 1-11



Part 2 Getting Started

An illustrated tour of the scope, then 'hands-on' for a run through its basic functions.

Front-Panel Controls	2-2
Installation Check	2-4
Initialization	2-4
Waveform Acquisition	2-7
TRACE ON/OFF	2-8
TIMEBASE Controls	2-9
Vertical Controls	2-10
TRIGGER Controls	2-11
ZOOM	2-12
CURSORS/MEASURE	2-14
Waveform Parameters	2-16
Summed Averaging	2-17
Fast Fourier Transform (FFT)	2-20
Waveform Storage	2-21
Save and Recall Setup	2-23

**Part 3 Sharpening Your
Measuring Skills**

Performing the most common measurements using the scope, in a series of easy-to-follow, step-by-step tutorials.

First Steps in Measuring	3-2
<i>The basic steps for setting up practically any measurement.</i>	
Digitizing with All Eight Bits	3-6
<i>How to set up the scope for digitizing on all eight bits.</i>	
Characterizing a Pulse	3-9
<i>Parameter measurement and statistical values made easy.</i>	
Accurate Measuring with Cursors	3-16
<i>Ensure accurate measurements.</i>	
Using Average to Remove Noise	3-26
<i>Reduce non-systematic noise and improve the signal-to-noise ratio.</i>	
3-D Viewing with Analog Persistence	3-31
<i>Explore the new dimensions Analog Persistence reveals.</i>	
Colors that Link and Distinguish	3-39
<i>Color Association makes signal viewing clearer and easier.</i>	
Cutting Deadtime Between Events	3-53
<i>For a choice of single-shot waveform segments without deadtime.</i>	
The Scope as Spectrum Analyzer	3-63
<i>Perform signal power distribution as a function of frequency.</i>	
Precision Analysis with Histograms	3-70
<i>Use the WPO3 option to display and calculate signal jitter.</i>	
Interpolation = More Information	3-87



Process acquisitions of a few sample points.

Testing Against a Telecom Mask3-96

Telecom-measure pulse-shaped signals to industry standards.

Storing to Removable Hard Disk.....3-109

The portable PC Card hard disk drive (HDD) simplifies storage.

Calculating on Long Waveforms.....3-114

Handle longer FFTs and multiple long-waveform zoom, math and storage.

SMART Glitch-Capturing3-127

Find and capture glitches with the SMART Trigger.

Capturing Rare Phenomena.....3-135

Use the SMART Trigger to increase knowledge of rare waveforms.

Triggering on Lost Signals3-144

Ideal for detecting interruptions in data streams.

Transferring Data to PC3-150

By GPIB, floppy or RS232 communication port.

Transferring Images to PC3-158

Copy screen TIFFs and BMPs to computer.

About this Guide



The title itself is explicit: this is a practical guide that shows you what the scope can do *as you operate it*. The guide offers a helping hand to both the beginner and the experienced operator of digital storage oscilloscopes (DSOs). It can be opened at almost any page and used to enable you to get the most out of the instrument.

All About the DSO

— an overview of the principles of DSO operation, including data sampling, triggering, recording, how sampling rate affects usable bandwidth and how long memory improves sampling rate.

Getting Started

— shows you around the scope and step-by-step how to capture waveforms and perform basic measurements.

Measuring Skills

— a set of tutorials describing — again, step-by-step — how to make the most useful measurements using the scope's advanced functions.

“HANDS ON” FOR THE COMPLETE PICTURE IN SIGNAL CAPTURE, VIEW AND ANALYSIS.

All About the DSO

Why and how is the Digital Storage Oscilloscope (DSO) so useful? What are the many ways in which it can be put to work for you?



Part 1 maps the digital landscape and shows you where to find and mine its riches. Basic concepts are explained and the main digital concepts and techniques outlined. The advantages of your LeCroy scope are also covered.

Having completed Part 1, you'll then be ready to zoom in on your scope in Part 2.



What the DSO Does and How

The digital oscilloscope is the essential instrument used to capture, view and analyze waveforms, measure signal characteristics and document the output.

There are three main DSO categories. Top-end models with a bandwidth of around 400 MHz or more are the most suitable for R&D-type work. The 100–200 MHz models are good for professional and general purposes. And the sub-100 MHz, low-cost scopes, are useful for work on low-frequency signals.

Basic Elements

The way in which each element of the DSO works separately and in conjunction with the other elements:

- ⇒ **Amplifier** — amplifies the input signal so that it can be measured
- ⇒ **Analog-to-Digital Converter (ADC)** — converts the analog signal into digital form by translating it into a series of sample points that are then measured and transformed into digital codes representing the signal samples
- ⇒ **Acquisition Memory System** — stores resulting digital data
- ⇔ **System Memory** of up to 64 MB

- ⇒ **Processor** — controls the entire system and performs special monitoring and measurement functions
- ⇒ **Display System** — translates stored data into a graphic display of the signal.

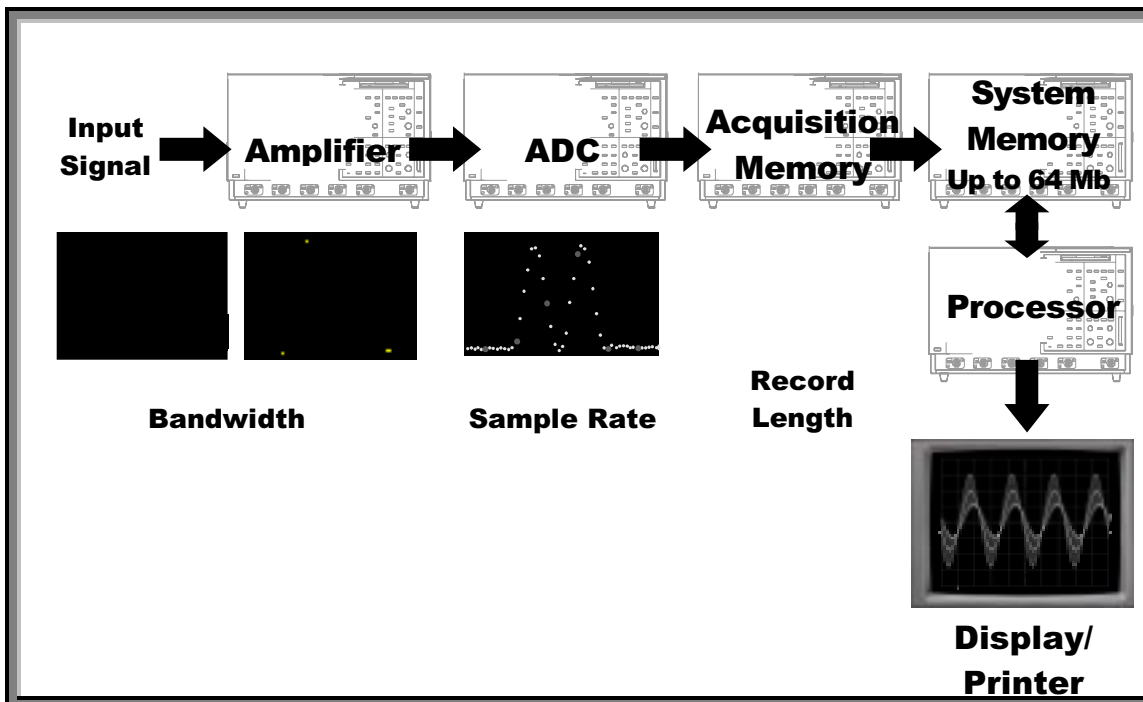

The character of your signals will determine the primary specifications of the DSO you will want to use. While your DSO's secondary specifications will be determined by the demands of your applications. In assessing the overall signal representation quality of a digital oscilloscope, particular consideration needs to be given to the cardinal parameters of **bandwidth**, **sample rate**, and **acquisition memory length**.

Bandwidth

The bandwidth specification of a DSO indicates the ability of its front-end amplifier to faithfully track an incoming signal. The DSO's bandwidth is defined as the frequency at which a sinusoidal input signal has been attenuated to about 70 % of its real amplitude. This point, at which the vertical amplitude error is about 30 %, is called the **-3 dB point**. It is generally advisable to use an instrument whose



The Digital Storage Oscilloscope

bandwidth is five times greater than the highest frequency component of the signal to be studied.

Sample Rate

The higher the sample rate the better the signal resolution. This is particularly important for single-shot waveform capture and measurement. The danger with low sample rates is that important information may be lost between samples. Accurate waveform capture requires a sample rate of at least five times the highest frequency component to be captured. For repetitive signals the sample rate is a less critical factor, as the signal can be captured over many cycles.

Memory Length

Acquisition memory length determines the number of input signal samples that can be stored. The greater the capacity for stored samples, the faster the possible sample rate for a given waveform duration. The signal captured with a long-memory DSO has a greater resolution, while for short-memory DSOs, the high sample rates quoted are only available at a few fast time-base settings. Long-memory DSOs allow operation at the highest possible sample rate, and over a far greater number of timebase settings.

<i>How Are DSOs Useful?</i>	<i>The DSO can perform the same operations as an analog oscilloscope and much more:</i>
<i>Capture</i>	<i>Capture of one-off (single-shot) events, stored in memory</i>
<i>Capture and Display</i>	<i>Data stays on screen while the scope waits for the next trigger</i>
<i>View and Record</i>	<i>View of the waveform before the instant of triggering, recording an event's cause and effect.</i>
<i>Analysis</i>	<i>Analysis of signals, providing precise measurement results</i>
<i>Documentation and Data Transfer</i>	<i>Documentation of signals, and the transfer of data via storage media to PC, or direct to print using an internal or external printer, or to a plotter.</i>

The DSO's fidelity in reconstructing the input signal is mainly affected by these three parameters (by others, too). The bandwidth must be sufficient to allow all the signal components to pass through the signal-conditioning system. And the sample rate has to be high enough to provide a good definition of the signal. Long memory maintains the sample rate for large time windows.

Signal Capture

In addition to the primary specifications described above, capture techniques, trigger system, number of channels, availability and type of probes, and ADC specification all impact the usability and performance of the DSO.

Acquisition Technique

Single-shot acquisition is the DSO's basic acquisition technique, which makes the instrument very suitable for the study of signal phenomena that have a low-repetition rate or are not repeated — hence *single-shot*. The timebase sweeps and stops at a time after receiving the trigger signal defined by the user. The captured input data signal is transferred to memory for viewing, measurement and analysis.

The DSO may also employ a technique called **Random Interleaved Sampling (RIS)** to increase its effective sampling rate in viewing repetitive signals. LeCroy's high-performance model has a maximum rate of 10 giga-samples per second.

For slower timebases, there exists **Roll Mode**, where the signal being acquired can be displayed in real time while being captured in memory, scrolling as on a strip-chart recorder.

Because digital scopes acquire input signals by sampling, they can miss glitches at the lower sample rates. But LeCroy's **Peak Detect System** captures glitches occurring between these samples. When the system is activated, the scope samples at a very fast rate, continuously checking for glitches using a built-in algorithm. Meanwhile, it displays information in accordance with the sweep rate actually set. When a glitch is detected, the scope will display it as a thin spike on the displayed waveform.

Another of the LeCroy scope's methods for acquiring signals is **Sequence Mode**, which captures individually multiple trigger events

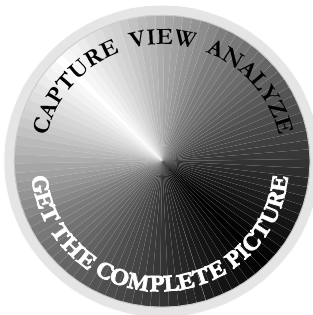



The Digital Storage Oscilloscope

separated by dead periods that would otherwise be unacquirable. When triggering in this mode, the scope grabs a pre-programmed number of samples, resets its trigger, and awaits another event. The resulting waveform is a splicing together of all the waveforms acquired. This eliminates the information-poor deadtime that would appear between triggers if the scope triggered on the first event and then continued to run. Sequence Mode allows acquisition of closely-spaced trigger events.

Analog-Digital Conversion High-speed DSO performance is made possible by the use of advanced ADCs whose vertical resolution will guarantee a clear representation of the signal. These ADCs measure the voltage level at evenly spaced intervals and store the digitized value in high-speed dedicated memory. The shorter the intervals, the faster the digitizing rate — and the finer the time structure able to be seen. The higher the resolution of the ADC, the better is its sensitivity to small voltage changes. And the greater its memory capacity, the longer the recording time that will be available.

Number of Channels Your LeCroy DSO has four channels, as well as an external trigger channel and a CAL BNC output connector. The CAL BNC can be used as the source of a calibration signal, an output pulse on the occurrence of each trigger, or an output pulse signaling a **Pass/Fail** condition.

Triggering The power of a DSO in any given application depends on a combination of several features, and particularly on whether it is able to trigger on the event of interest. A trigger system far more sophisticated than that found in conventional oscilloscopes is needed for capturing rare phenomena such as glitches or spikes, logic states, missing bits, timing jitter, microprocessor crashes, network hang-ups or bus contention problems. Your LeCroy scope incorporates this more sophisticated system.

Unlike manufacturers who put their 'best' trigger design into their more expensive scopes and a less adequate one into the lower-bandwidth, economy models, LeCroy offers all its DSO users, at every bandwidth, both a standard edge trigger *and* a powerful **SMART Trigger** for capturing elusive events.

A push-button control switches from one of these triggers to the other. Moreover, the LeCroy DSO has a variety of advanced trigger modes. The functioning of these modes is based on two important features. The first is the ability to preset the logic state of the trigger sources: channels CH 1, CH 2, CH 3, CH 4, and EXT and EXT/10. The second is a counter that can be preset and used to count a number of events between 1 and 10^9 , or to measure time intervals from 2.5 ns–20 s in steps of 1 % of the time scale.

In combination, these twin capabilities open the door to a wide variety of trigger conditions. But great care has been taken to maintain the SMART Trigger's 'user-friendliness', without losing this versatility. Icons illustrate the trigger conditions on-screen for every mode.

Signal Viewing



The DSO's display system translates stored data into a graphic representation of the signal and shows it on the screen. Also displayed are internal status and measurement results, as well as operational, measurement and waveform-analysis menus.

The LeCroy DSO's large screen and a waveform grid that fills the viewing area accelerate visual processing and facilitate more effective communication of on-screen information. Other advanced display techniques give major performance improvements over conventional analog or digital scopes. A hardcopy of the screen contents can be produced at the press of a front-panel screen-dump button. Multiple waveforms can be viewed on separate grids, ensuring the best utilization of the ADCs' dynamic range. XY and variable persistence displays are also provided, as is **Enhanced Resolution Mode**.

A wide range of processing functions can be performed. Four traces — A, B, C and D — are available for zooming exclusively or together with waveform mathematics. The horizontal expansion can be huge, greatly improving the time resolution on the viewed trace. Several traces can be zoomed onto the same waveform for precise timing measurements.



Measuring

Measuring signal characteristics and analyzing circuit performance is at the heart of test engineering.

Most DSOs can measure parameters, but analyzing their statistics can be a time-consuming chore. LeCroy's parameter measurements and statistics allow worst-case analysis of circuit performance and make the process much faster.

Pulse Parameters

Cursor readouts allow use of full ADC resolution to measure a waveform's absolute or relative times and amplitudes. However, most users measure the same waveform parameters, such as risetime, falltime, pulse width, overshoot, undershoot, peak voltage, peak-to-peak voltage, maximum, minimum, standard deviation, rms value, frequency, and period. These and many other parameters are available using your LeCroy oscilloscope.

Waveform Math

Waveform math allows the display of final answers, rather than raw data. For example, inputs from voltage and current transformers can be multiplied together to display power. An important LeCroy DSO feature is the ability to 'daisy-chain' math functions: a power trace can be integrated to display energy, for instance.

Signal Analysis

A great advantage of digitizing is the added ability to analyze data. Once the analog signal has been converted into digital data, the data can be analyzed either by the DSO's internal digitizer processor or by an external computer. Most current digitizers have a wide analysis spectrum built-in. Depending on the model and its options, LeCroy DSOs offer a selection of the following analytical features.

Time Domain

The optional time domain waveform analysis package — includes zooming, summed averaging of up to one million sweeps, derivatives, logarithm, square root, absolute value, ratio, six digital filters and standard arithmetic operations. The zoom feature on high-performance models expands the waveform so that the individual data are very clearly separated.

Frequency Domain

Spectrum analysis greatly extends the DSO's processing power and offers two clear advantages over **FFT (Fast Fourier Transform)** analyzers: higher frequency components, and the ability to monitor both time and frequency information. Fourier transform converts sampled waveform information into a unique set of sine wave components. The data is usually plotted as amplitude vs frequency, exposing information not easily visible in the time domain (amplitude vs time). Ideally, it can be used for such analyses as measuring frequency components of communication signals and monitoring drift in an oscillator. The frequency resolution of an FFT is directly proportional to the number of time-domain points the FFT algorithm can handle.

Statistical Domain



The existence of measured waveforms in digital representations permits convenient use of the data inherent in those measurements. As well as analysis of signals in the frequency domain and the ability to perform mathematical operations and signal averaging on data, trends can be determined and **histograms** of the data analyzed.

The histogram is a graph of the distribution of values of a measured parameter. For example, when measuring the risetime of a repetitive signal for which all the measurements are equal, the histogram will be a straight vertical line without breadth. However, variations in risetimes create a plot with some horizontal structure, implying variations in the measurements. Your LeCroy DSO is able not only to



The Digital Storage Oscilloscope

create such histograms, but also to allow measurement of their characteristics. This is extremely useful when analyzing pulse amplitudes, widths or timing jitter.

Other LeCroy analysis techniques include **Pass/Fail** testing, **Mask Comparison** testing, **EYE-diagram analysis** for telecom applications, and the specialized testing for magnetic media applications, **DDM (Disk Drive Measurements)** and **PRML (Partial Response Maximum Likelihood)**.

Documentation

Storage and recording functions are key requirements in many test applications. The LeCroy digital scopes produce excellent output, in the form of either digital data or hard-copy records.

Removable HDD

Files saved in the TIFF format can be imported into PCs and other computers. The portable **PC Card HDD (Hard Disk Drive)** is a PCMCIA Type III device much faster than a floppy disk and with far greater capacity that can be popped in and out of your LeCroy DSO or computer. There is an HDD adapter on the rear panel of your scope.

Note that test data can be processed far more quickly *inside* a DSO, and saved on the scope's internal HDD, than by transfer via GPIB link to computer.

The PC Card Memory Card drive and built-in floppy disk drive — located on the front panel of your LeCroy DSO — can also be used to store waveforms and screen shots. The built-in thermal printer is quick and convenient for producing a screen-output plot. The scope can output to a printer through its parallel port.

Interfaces

Your LeCroy DSO can be controlled remotely through its IEEE-488 or RS-232 ports. As well as storage, printing and transfer to memory devices, the scope offers push-button transfer of waveforms and settings to the LW series of arbitrary waveform generators. This enables, for example, a reference waveform to be captured from a known good device and used as a test stimulus applied to other devices.



Getting Started

Part 2 introduces the scope's main features and runs through them with you. You'll get a basic idea of what the instrument can do and start working with it quickly and effectively.



Following this, you'll be ready to go on to Part 3, and to connect your own signals to the scope.

For complete details on all features of your LeCroy color digital oscilloscope, see the accompanying *Operator's Manual*.



The Front-Panel Controls

The main controls you'll be using here:

AUTO SETUP

— acquires and displays repetitive signals in less than two seconds.

ANALOG PERSIST

— for the unique Analog Persistence™ feature: each persistence data map is displayed in various intensities of the trace color.

FULL SCREEN

— expands the waveform and grid to fill the entire screen.

TIMEBASE + TRIGGER

— includes trigger-mode, -level and -position selection, as well as **TIME/DIV** control.

CHANNELS

— turns the input channels on and off, and controls the **OFFSET** and the vertical sensitivity for input channels. The **VAR** button, also in this group of controls, gives variable, fully calibrated sensitivity throughout the scope's range.

SYSTEM SETUP

— the dark-gray menu-*entry* buttons that dominate this group access the main on-screen menus and the acquisition, processing, and display modes. The two knobs adjust menu values and command cursors.

Menu Buttons & Knobs

— seven buttons and two knobs that control on-screen menu selection. Each controls the menu to its immediate left on the screen.

ZOOM + MATH

— allows the selected trace to be moved and expanded or have a mathematical operation applied to any of the scope's channels or other Zoom/Math functions.

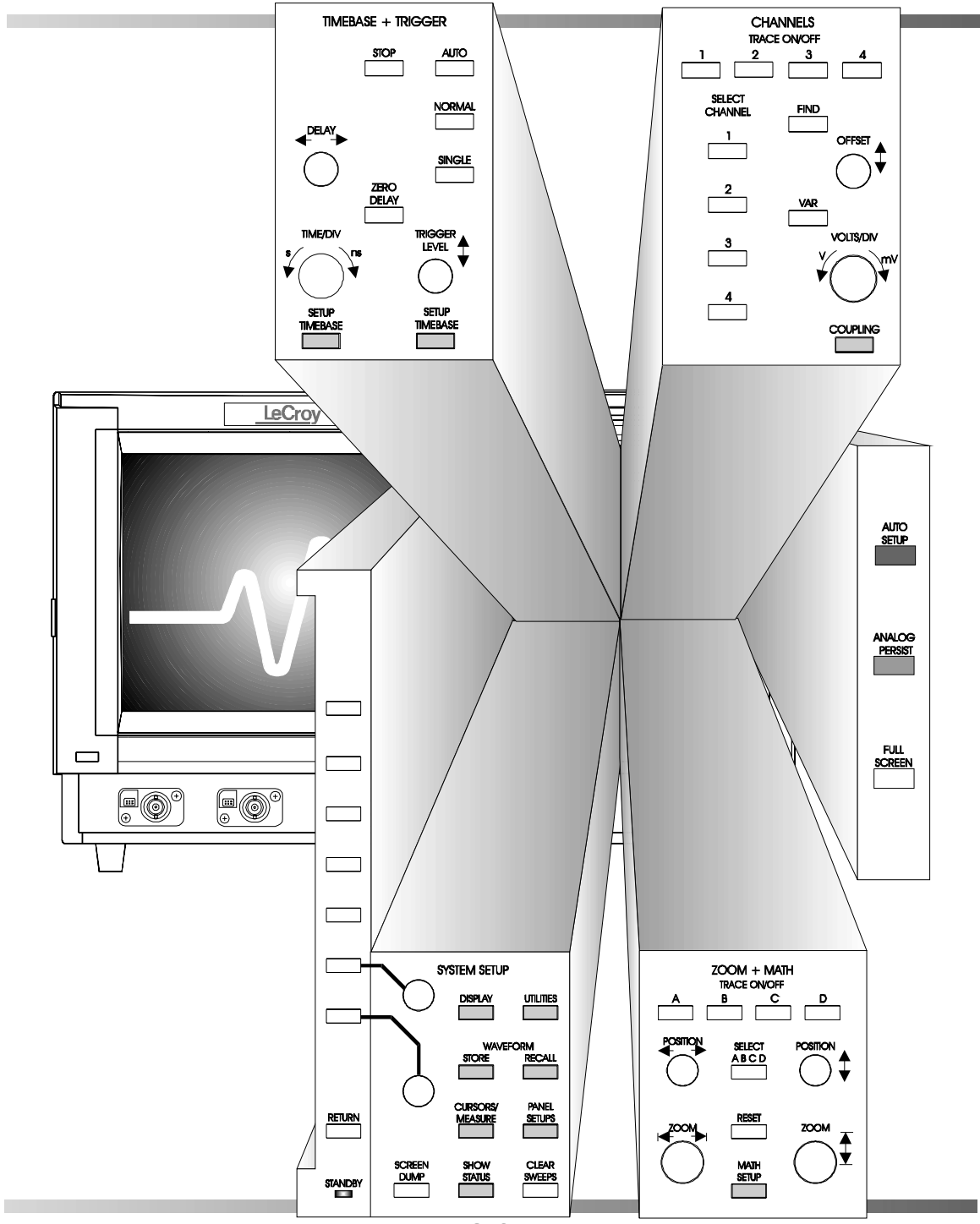



Installation Check

Before powering up, check that the local power source corresponds to the scope's range — any AC power source of 90–250V, 50 or 60 Hz. (See the *Operator's Manual* for Safety details.)

Use the cable provided to connect to the power source. Then turn on the scope by pushing the POWER button at the bottom left-hand corner of the front of the scope.

Before a display appears, the instrument will perform hardware and software self-tests, followed by a full system calibration. The front-panel 'standby' LED light, located below the right-hand corner of the screen, will be illuminated during this sequence. The full testing procedure will take approximately ten seconds, after which the display will appear. *before powering up.*)

Initialization

To initialize the scope to its default settings and make your screen displays similar to those shown on the following pages:

First, press  on the control panel, illustrated on the facing page.

A column of menu boxes like the one shown here will appear at right-of-screen. Either "Recall" or "Save" will be highlighted.

Press the top menu  button to select "Recall".

Now press the "FROM DEFAULT SETUP" menu  button.

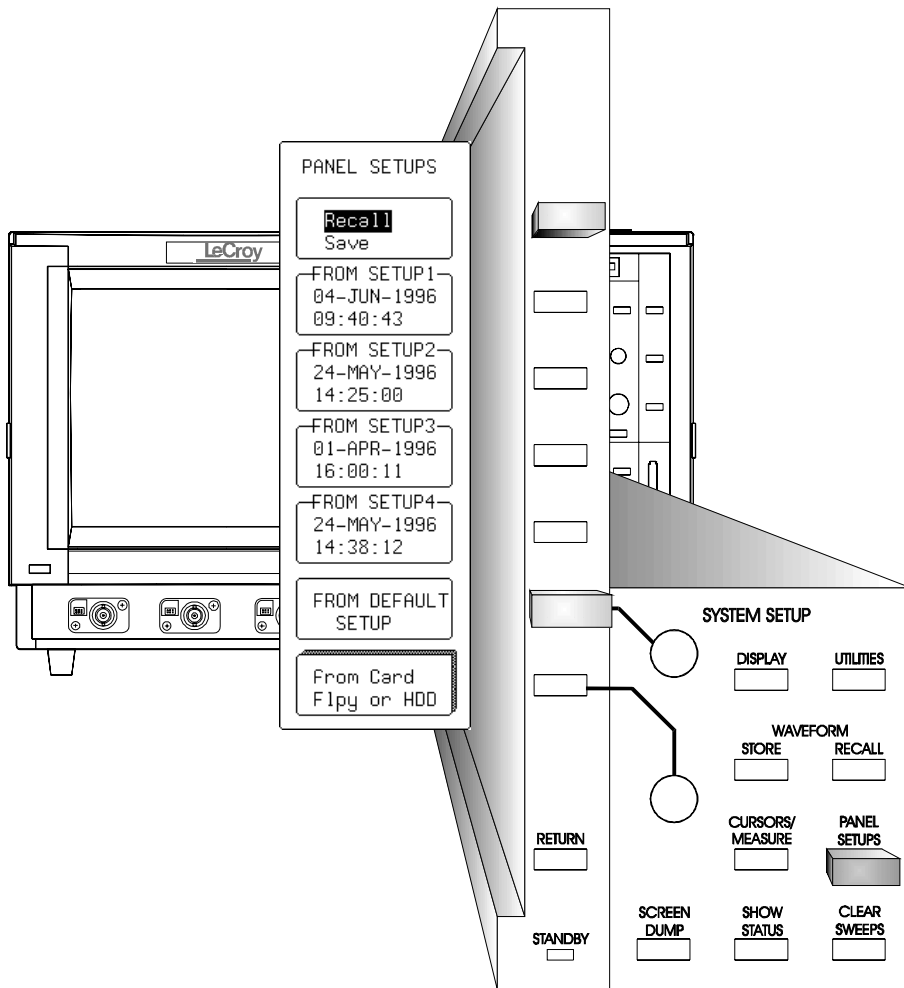

Note: When a word or number is highlighted on-screen, front-panel controls will apply to the function, action or trace represented.

Each menu button in the column of buttons running down beside the screen corresponds to the menu immediately next to it.

The individual buttons illustrated three-dimensionally in this drawing are those used for the actions described here. Throughout the guide, 3-D buttons and knobs that punctuate the text represent particular controls to be used, while the group illustrations show where they are found on the front panel.



Getting Started

With the scope initialized, we're ready to explore some of its basic functions.

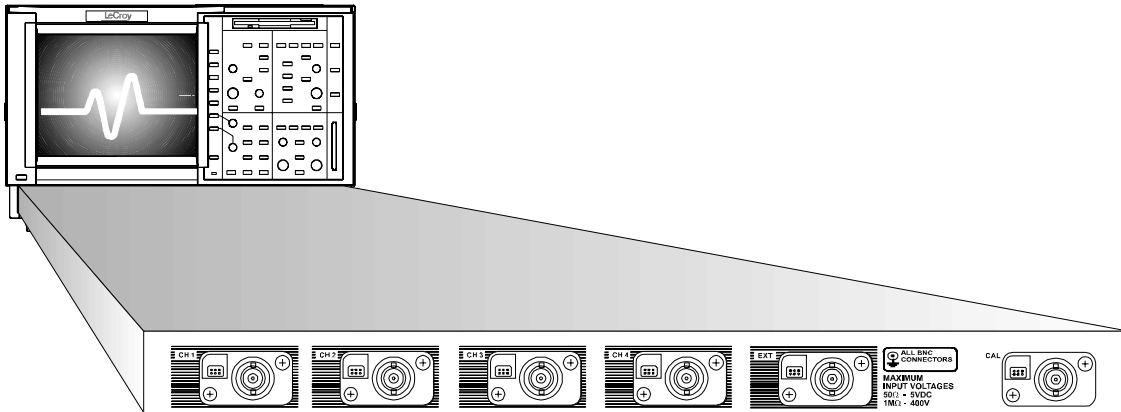

But first... We need a Signal!

Connect a BNC cable from the CAL output at right to the Channel 1 (CH 1) BNC input at left.

We can now go on to acquire and display waveforms.

Waveform Acquisition

AUTO
SETUP

Press the blue  button.

This will automatically set the trigger-level, timebase and vertical settings needed for displaying the input signal.

Note: Auto Setup is a particularly useful feature that facilitates the display of a wide range of repetitive signals, including those with duty cycles as small as 0.1 %.

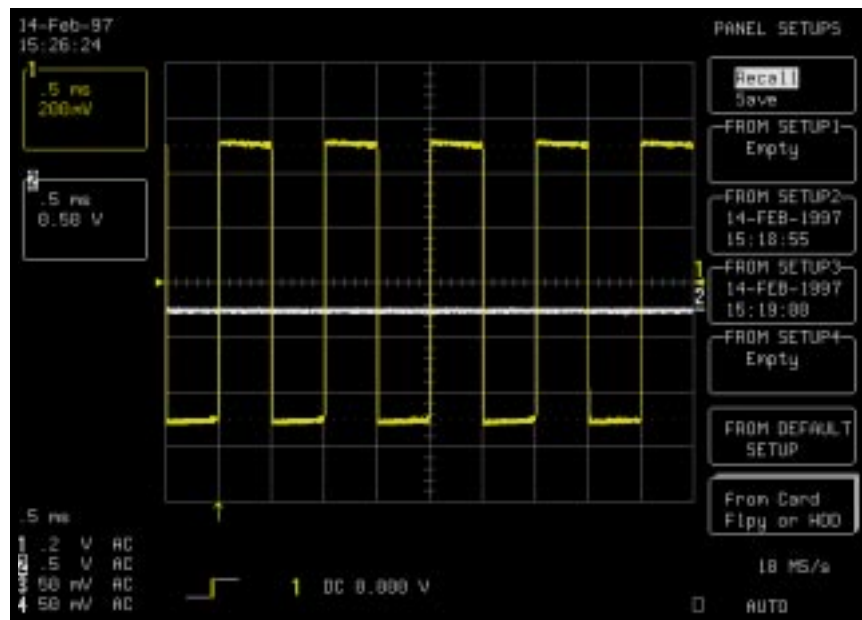

The screen will show a 1 kHz square wave. Both Channel 1 (the square wave) and Channel 2 (the horizontal line) are displayed.

Channels' time and volts per division are shown in the **trace labels** at top-left of screen.



TRACE ON/OFF

To switch off a channel — Channel 2 in this example:

Press the corresponding TRACE ON/OFF  button, located on the CHANNELS control panel.

This action removes both the trace and its label from the screen.

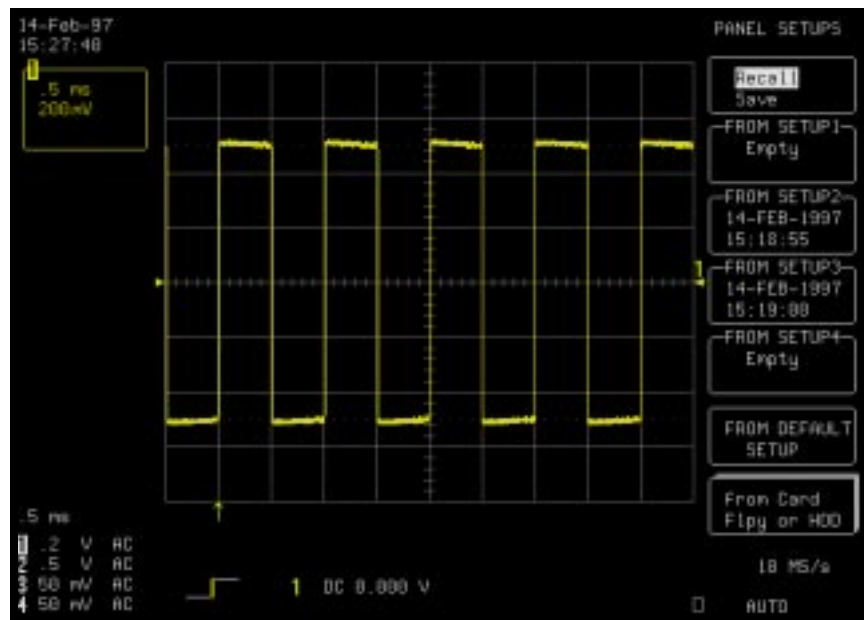
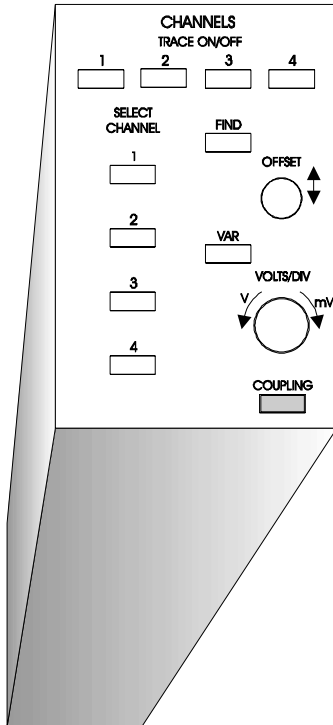

TIMEBASE Controls

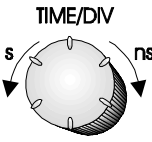
Use the  knob to adjust the timebase.

The selected time/division setting is shown on the lower left-hand side of the screen.

Now, to capture the signal for a shorter period, **change the setting to 0.2 ms/div.**

But make sure to reset it to 0.5 ms/div for the remainder of these exercises.

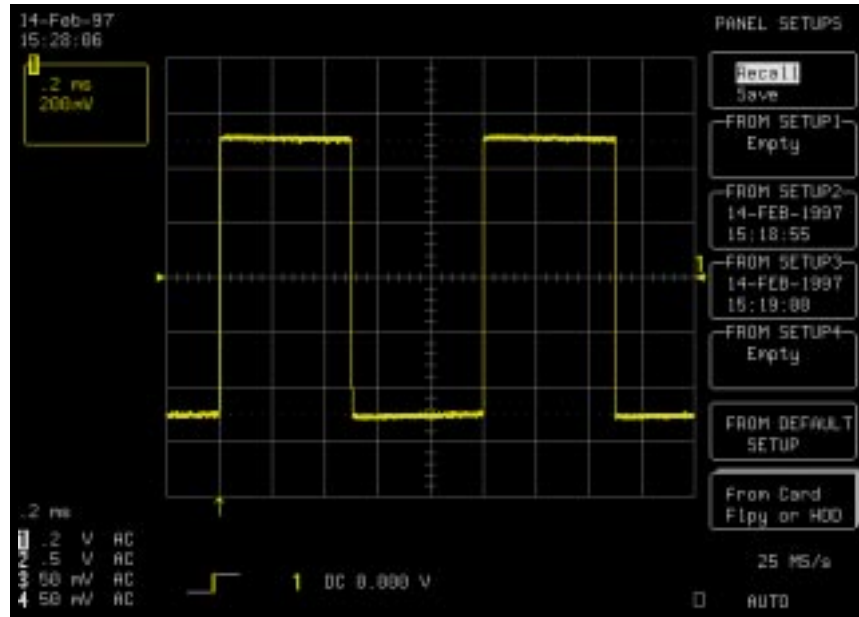
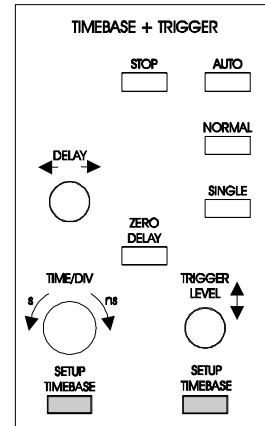



Getting Started

Vertical Controls

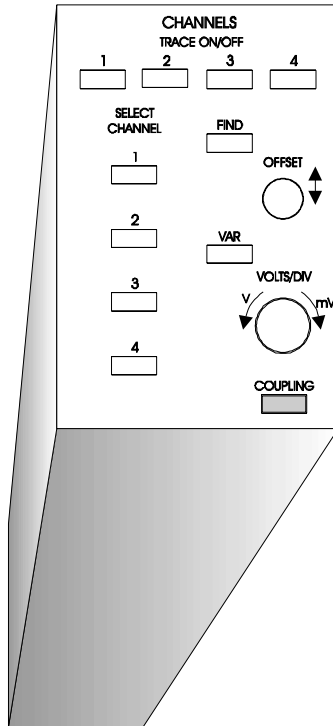

The VOLTS/DIV controls give a vertical gain selection of 2 mV–5 V/div, operating in a 1–2–5 sequence. To reduce the sensitivity:

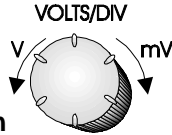

Turn **and set the gain to 500 mV/div**. The selected volts/div setting is shown in the Channel 1 trace label.

To fine-tune the vertical gain: Press the **VAR** button.

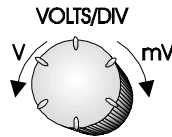

Turn **through several complete rotations, so that the entire signal reaches from top to bottom of the grid**. The volts/div setting still shows in the trace label

Filling the grid in this way ensures that the signal uses the full range of digitizing levels available — *8 bits = 256 levels* — for the best vertical resolution.

To return the vertical gain to its 1–2–5 sequence: Press **VAR** again.

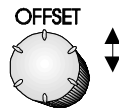

The knob controls the vertical position of the acquired trace.

Note the ground marker for Channel 1, **1**, next to the menus.

Press **2** to see that its channel, too, has a trace label. Press again to turn off Channel 2.

SELECT CHANNEL

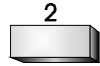



TRIGGER Controls

The smaller knobs on the scope's front panel are acceleration-sensitive — the faster they are rotated, the greater are the increments that result.

When more than one trace is displayed on the screen, the number of the selected trace is highlighted on its respective trace label. The vertical controls — including VOLTS/DIV, OFFSET and COUPLING — will operate for this trace only.

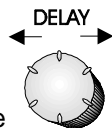
To choose another trace: **Press the desired SELECT CHANNEL button**, to which the controls will then apply.



The  knob adjusts the trigger's horizontal position — from 0% to 100% pre-trigger, and from left- to right-hand edge of the grid. This knob can also be used for setting the post trigger in seconds up to 10 000 divisions.

The trigger position is shown by  at the bottom of the grid.

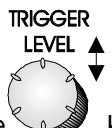

The  knob adjusts the trigger's vertical threshold.

Arrows on either side of the grid,  indicate the threshold position — arrows that are only visible if the trigger source is one of the traces on the screen, and then only if that trace input is DC-coupled.

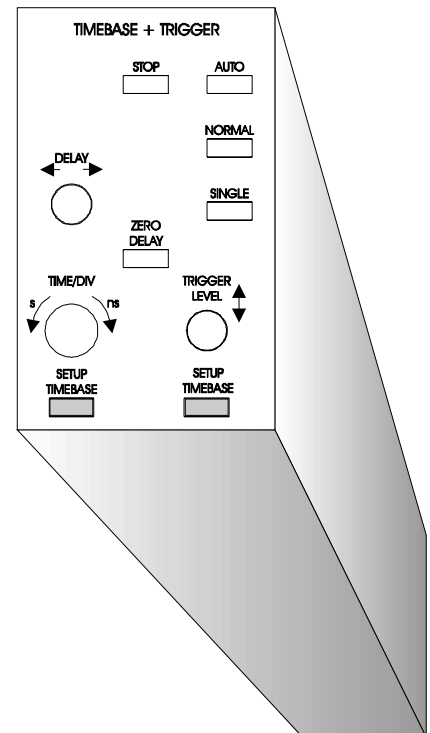

Zoom

Note: The Zoom function is an important benefit of the scope's acquisition memory. It can also be considered as an additional timebase providing alternative sweep speeds.

To expand — or 'zoom-in' on — a small section of the trace so that it can be seen in more detail:

Press 

Then press the corresponding  to select "Dual" from the "Grids" menu.

Now two grids are shown on the screen, giving optimum viewing of the expanded trace.

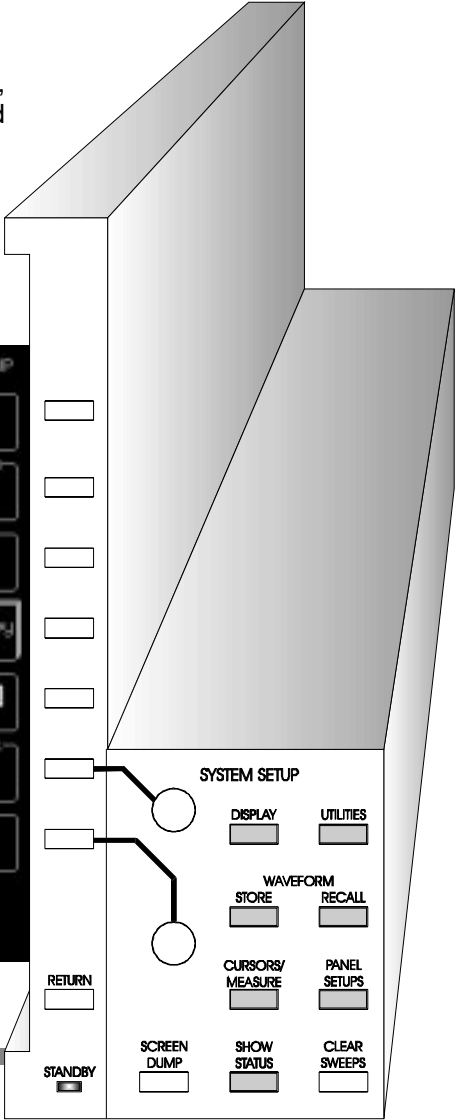
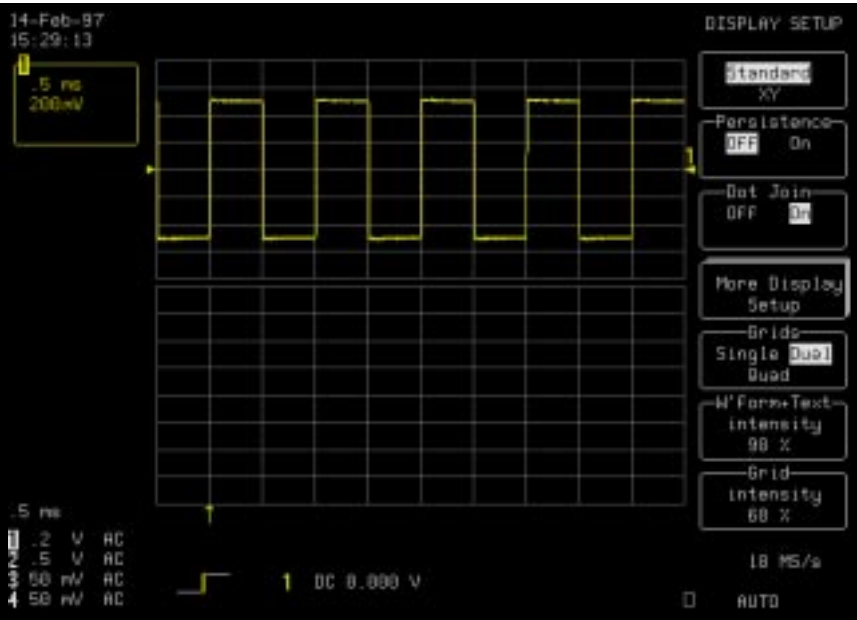

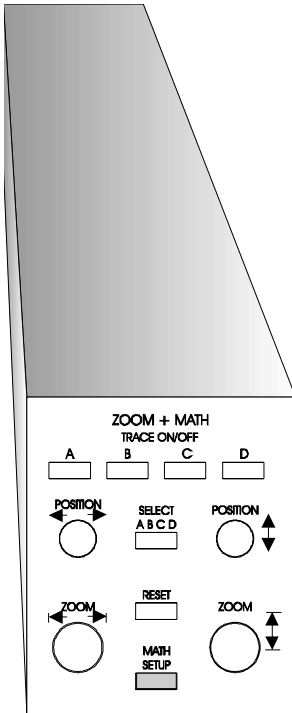

Now, press **A** to turn on Trace A .

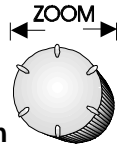

Turn **ZOOM** to adjust the expansion factor and increase the amount of zoom.

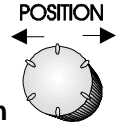

Turn **POSITION** to move the expanded part of the upper trace.

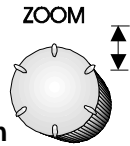

Turn **ZOOM** to expand vertically.

Note that the expanded part of the upper trace shows the section of the original waveform being viewed by the zoom.

Vertical and Horizontal settings for the zoomed waveform are shown in the "A" trace label.

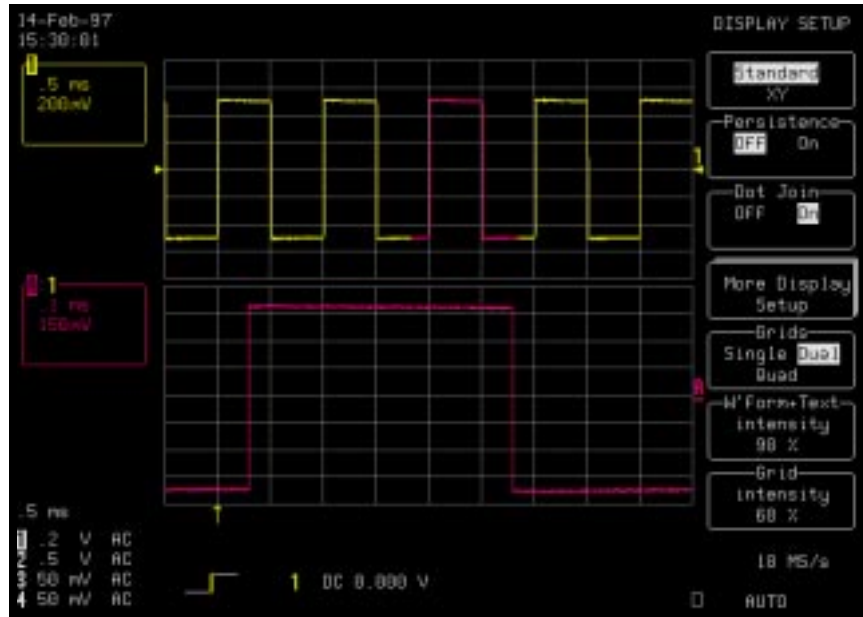





CURSORS/MEASURE

Note: Use cursors to make fast, accurate measurements and eliminate guesswork. (See the Operator's Manual and Accurate Measuring with Cursors in Part 3 of this guide for more about cursors.)

CURSORS/
MEASURE

Press  and use the respective s to select: "Cursors", "Time" and "Absolute".

Use the upper  'cursor position' knob to move the cursor.

The Absolute Time cursor appears as a cross-hair on the waveform. As the cursor moves, its time value in relation to the trigger point shows at the base of the lower grid, while indicated in the trace labels is its voltage/amplitude value.

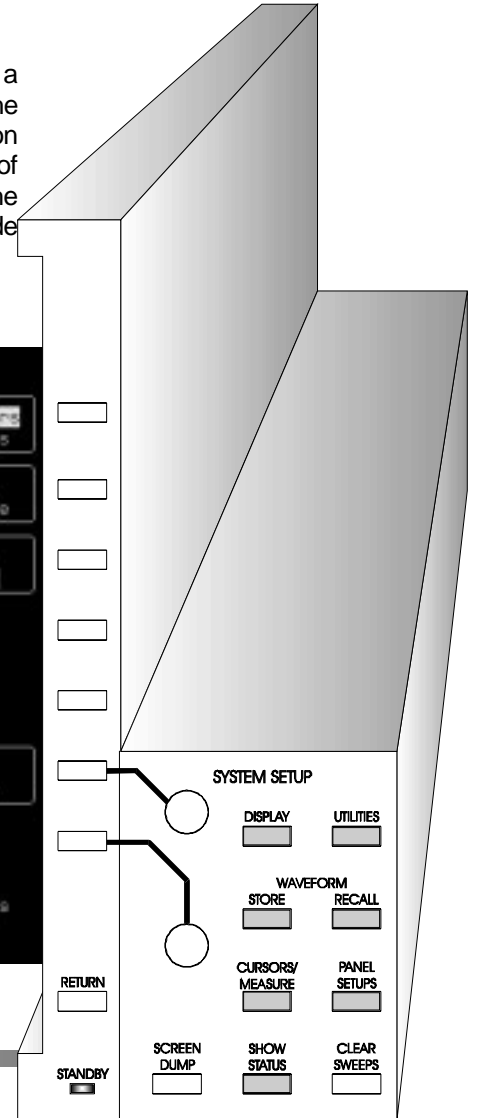
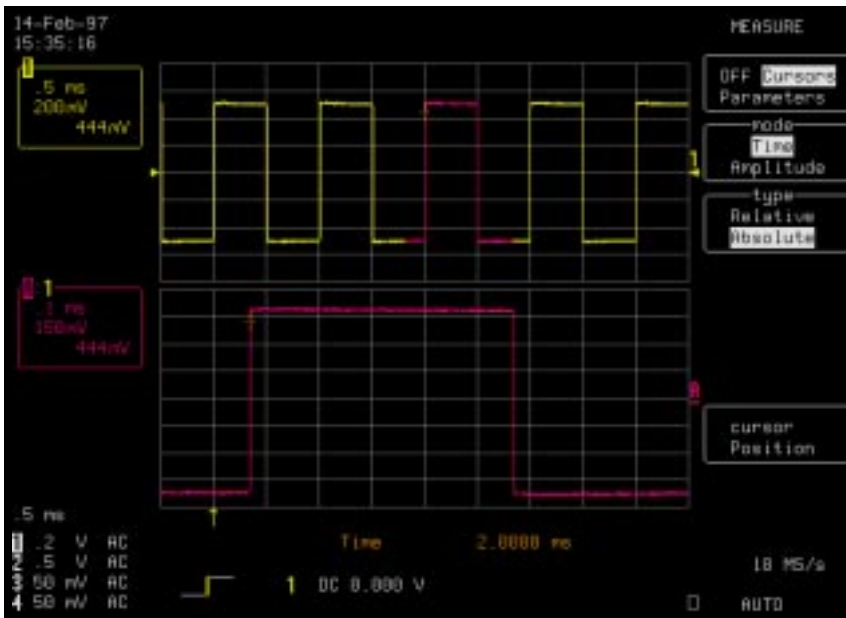

Press the corresponding menu  button to change the selection from “Absolute” to “Relative”.

Now *two* cursor menus are available, operated by the upper and lower knobs, respectively.



The Relative Time cursors appear as vertical arrows on the waveform.

Shown below the grid is the relative time difference between the cursors, while the trace labels show the voltage/amplitude difference.

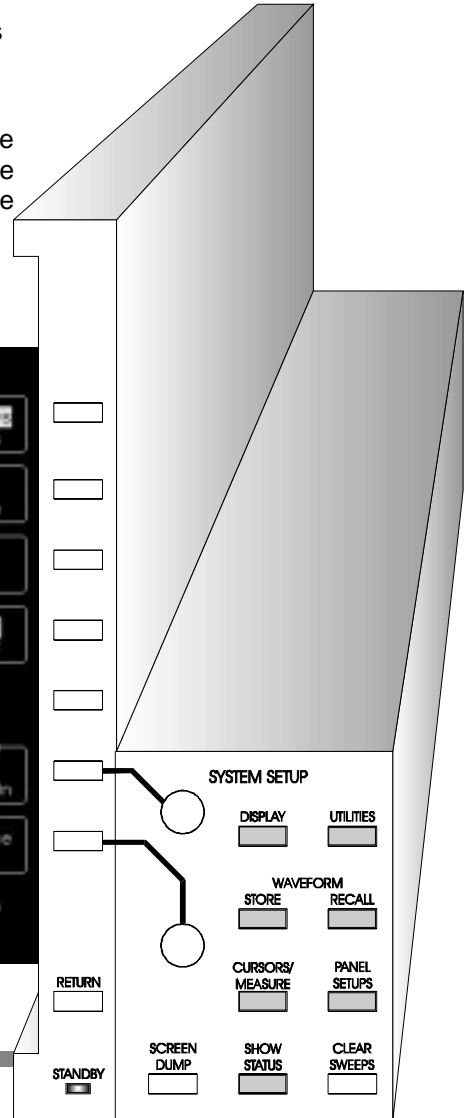
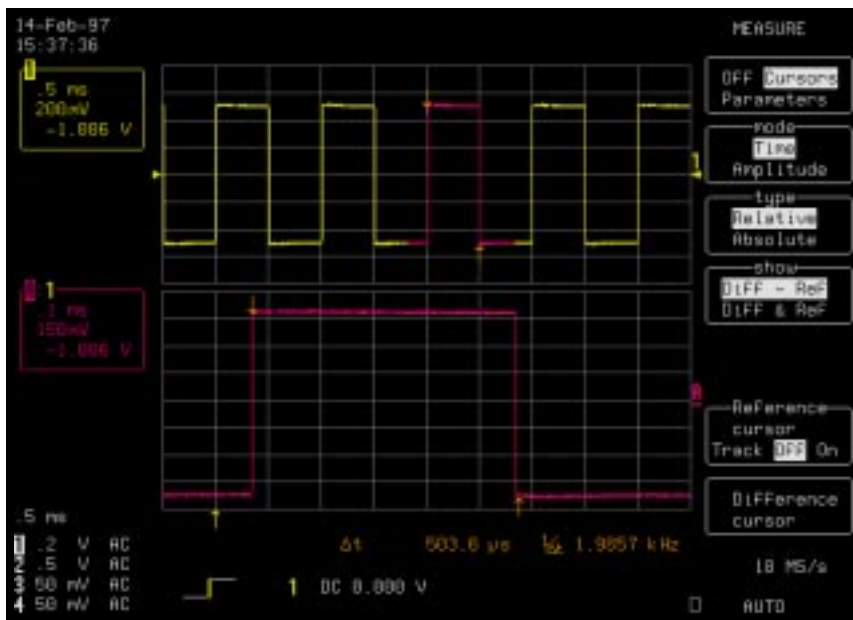



Waveform Parameters

Note: The scope's capacities go beyond cursor measurements to calculate useful pulse parameters — automatically and with high precision. This saves time, as cursors need not be positioned manually, nor do time and voltage values need to be estimated.

Press the top menu  button to select **“Parameters”**.

Appearing on-screen below the grid is a list of five different voltage parameters.

Press the corresponding  buttons to select from the **“mode”** menu **“Std Voltage”** and, next, **“Std Time”**.

The list of voltage parameters on-screen will be changed by these selections. The parameters are computed each time the trace is updated.

Press the corresponding  to select **“On”** from the **“statistics”** menu. You will now see the average lowest and highest values of each parameter and the standard deviation of the distribution of measurements.

To return to normal operation: Press the top  to select **“Off”**.

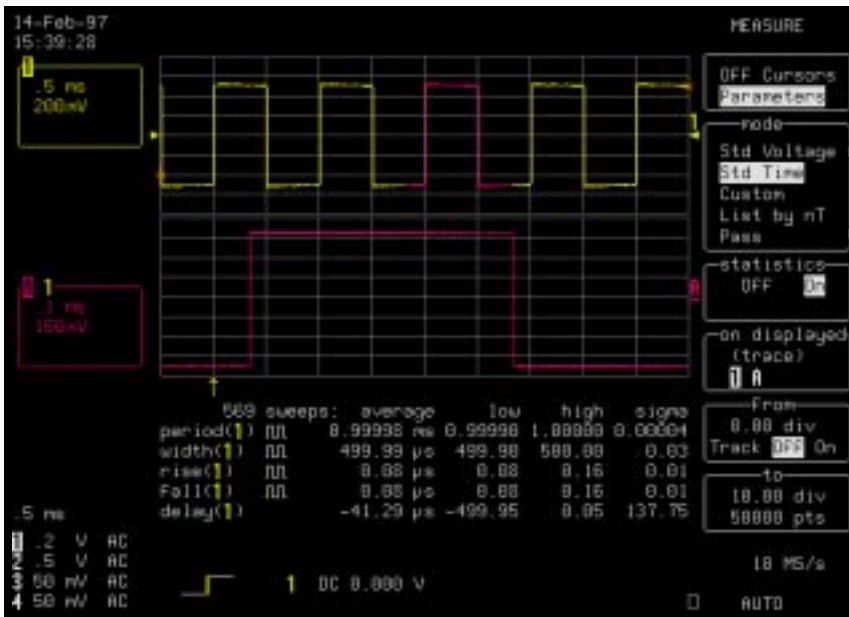

The **“statistics”** menu is very useful for tracking drift or other changes in signal behavior.

Summed Averaging

Use the Summed Averaging function to improve the vertical resolution of repetitive signals, or to average out unwanted noise on a live signal.

Press  to turn off Trace A and the ZOOM function.

Press  to turn on Trace C and ZOOM on it.

Now press 

The menus shown here will appear:

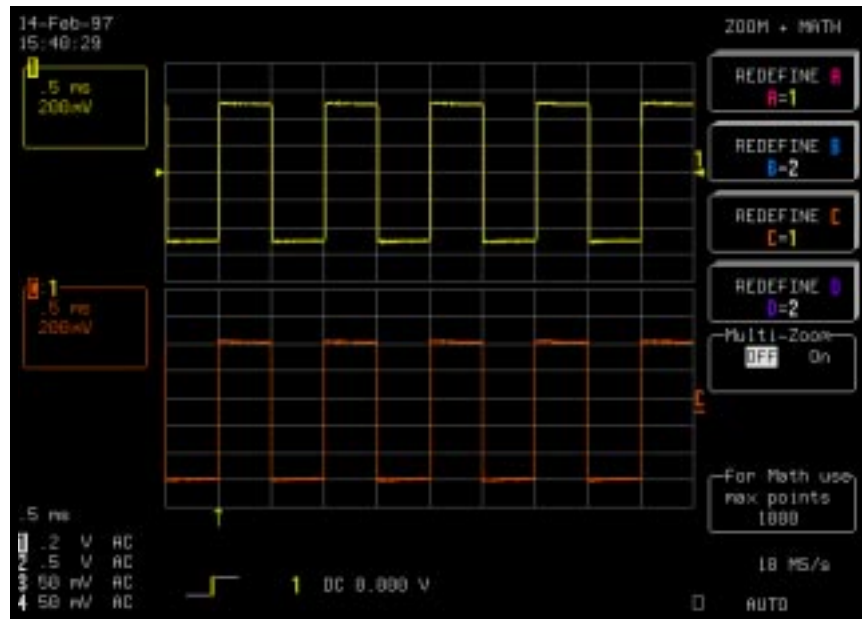
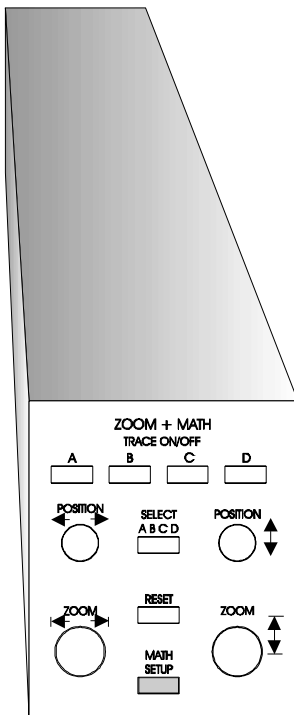



Getting Started

Now, press the corresponding  to select "REDEFINE C".

These menus will appear:

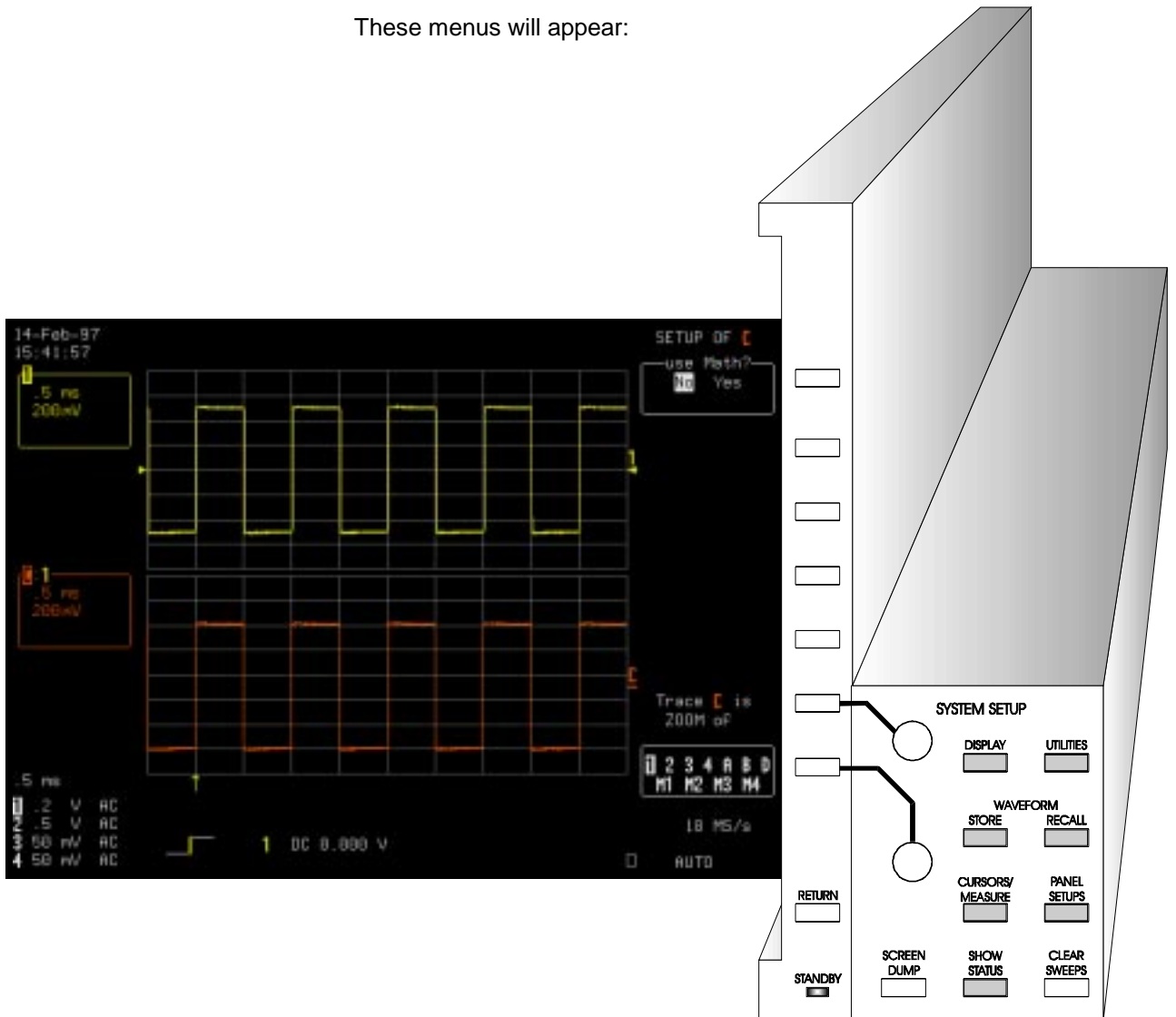

The scope may allow various types of averaging — see “Avg Type” menu — depending on its configuration.

Note the measurement resolution's increase compared with the live trace.

Press the corresponding  to select “Yes” from the “use Math?” menu. The screen will change to display the menus shown here.

Now use the corresponding  to select “Average” from the “Math Type” menu.

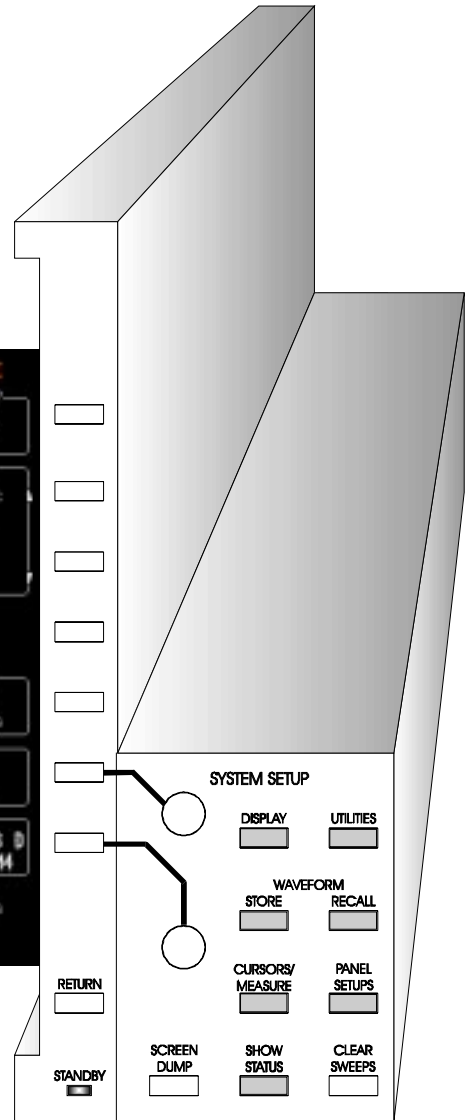
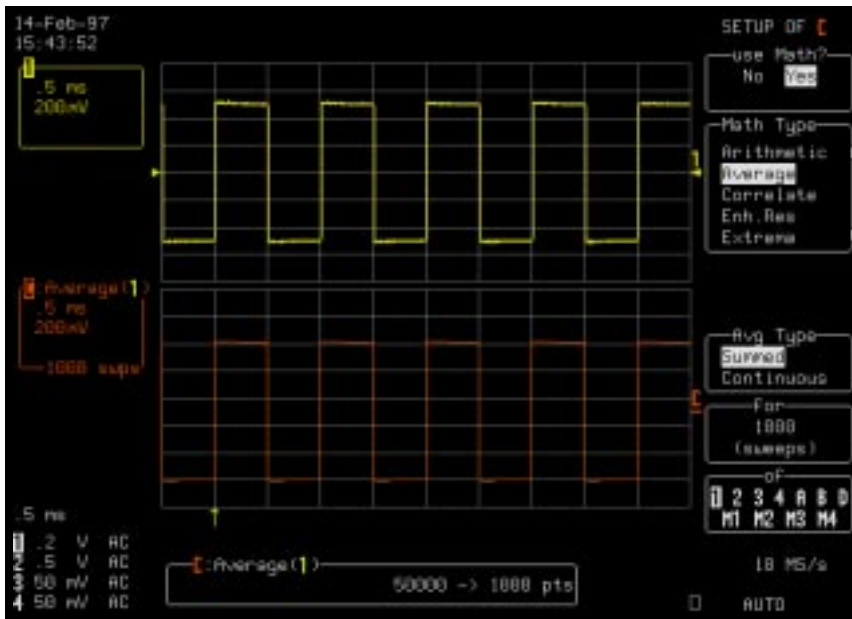



Getting Started

FFT

MATH
SETUP
Press

Note: Fast Fourier Transform (FFT) allows acquired waveforms to be converted into frequency-domain traces, revealing valuable spectral information that would otherwise be impossible to detect on a time-domain record.

Press the corresponding to select "REDEFINE C".

And then press those that will make the selections highlighted on the screen below.

The lower trace will show the FFT transform of the square wave on Channel 1. Now, you can use the absolute horizontal cursor to make a frequency measurement...

SINGLE
But first, press

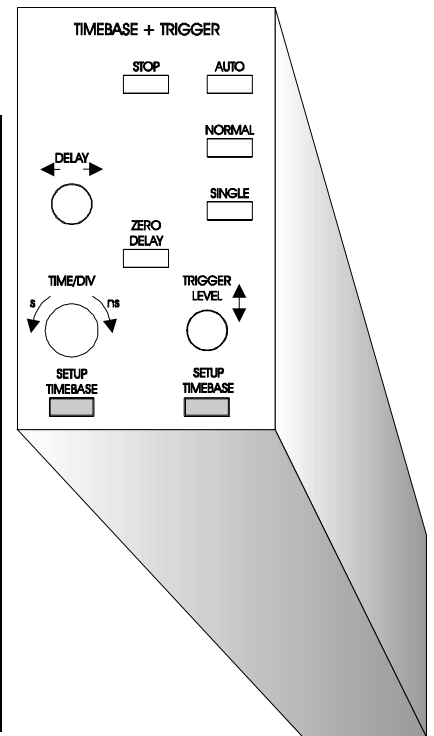
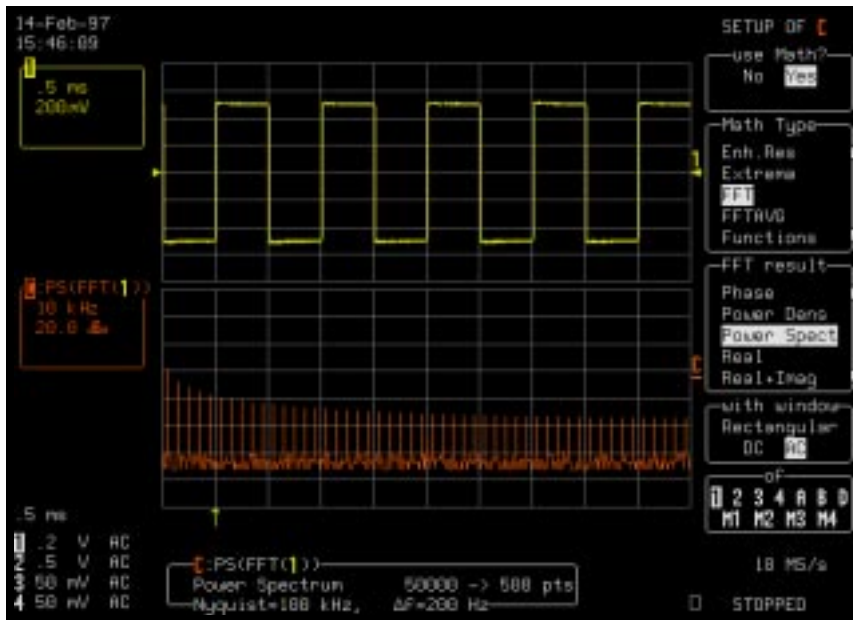

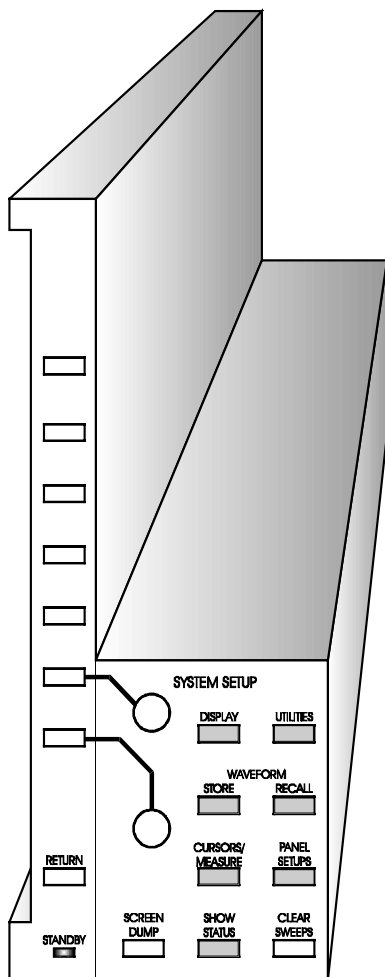

CURSORS/
MEASURE

Next, press 

Then press the corresponding  to select “Absolute” from the “type” menu.

Move the cursor to the right of the upper trace until it reaches the FFT trace.

Note that the readings are now labeled in Hz (horizontal) and dBm (vertical).

The first frequency component at left-of-screen should be the square wave’s fundamental frequency (1 kHz). The following components (3 kHz, 5 kHz, 7 kHz...) are the harmonics that contribute to building the square wave.

To return to normal operation: Press the top  to select “Off”.

NORMAL

Now press  to return to normal triggering.

The scope has four waveform memories: M1, M2, M3 and M4. In this example, the waveform will be stored in M2.

C

Press  to turn off Trace C and FFT.

STORE

Now press 

Then press the respective s to select “1” from the “store” menu, “M2”

Note: Waveform memories allow the temporary saving of waveforms for later comparison or analysis — an important benefit of digital oscilloscopes.

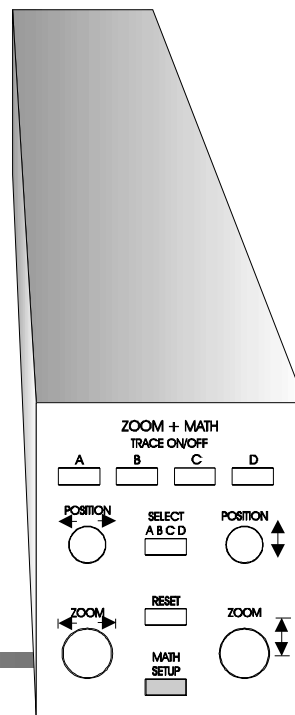

Note: As many as four waveforms can be saved and stored until overwritten by other waves or the scope is switched off.

Trace A displays the waveform saved in M2, which can then be repositioned and expanded using the ZOOM controls.

from the "to" menu, and "DO STORE (1 -> M2)".

RECALL

Then press [RECALL] to display the stored trace.

[M2]

Then press the [M2]s to select "M2" from the "from Memory" menu, and "DO RECALL (1 -> M2)".

A

And press [A] to turn off

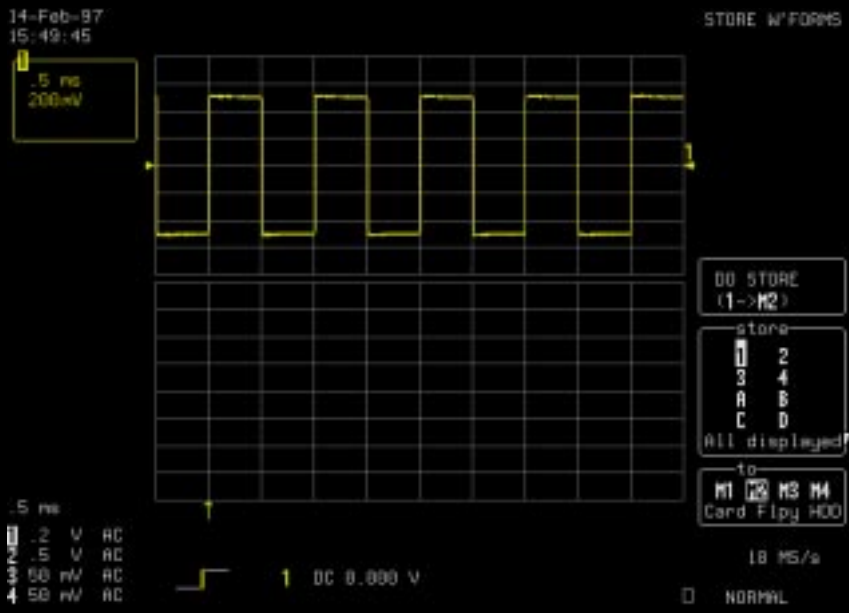

Trace A.

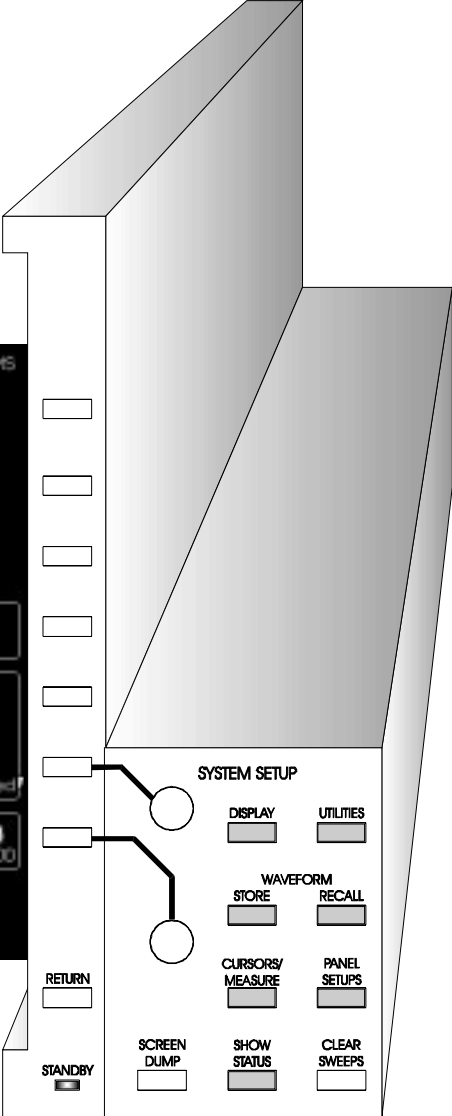

Save and Recall Setup

Note: Entire panel setups, such as those of often-performed measurements, can be saved and stored in non-volatile internal memory for later recall. Up to four setups can be stored (thousands with the optional DOS-compatible memory card, floppy or removable hard disk).

PANEL
SETUPS
Press 

Then the s to select "Save" and for "TO SETUP 1".

Now, as an exercise, randomly change Channel 1's

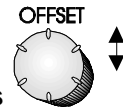

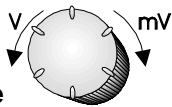
Change  and the Timebase, too.

Press the  to select "Recall", for the original settings.

Finally, press the  for "FROM SETUP 1". 

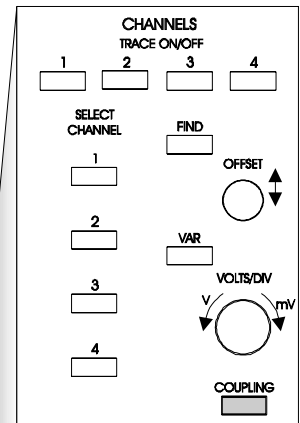
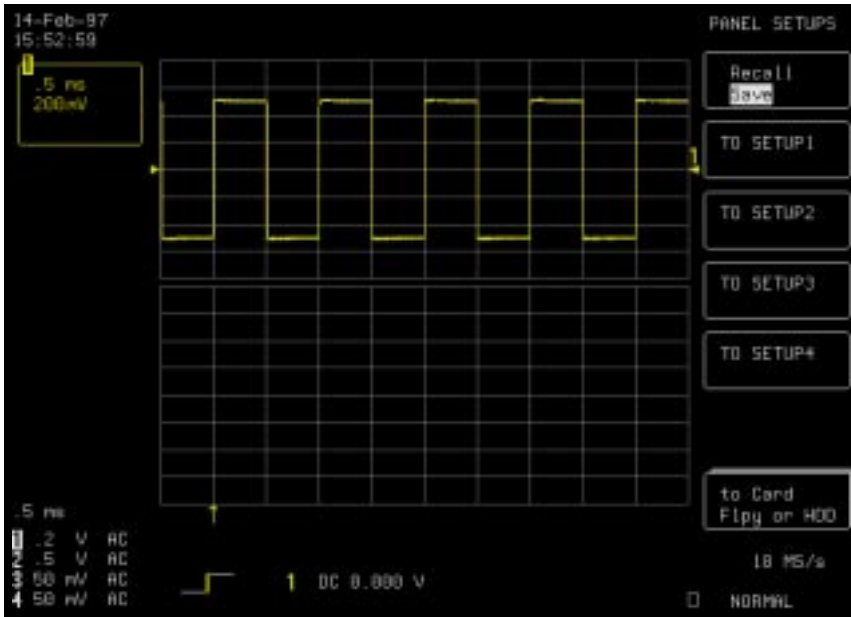

Sharpening Your Measuring Skills



The tutorials in Part 3 show you how to perform the most common types of measurements.

As in Part 2, the tutorials take a practical, step-by-step approach to familiarizing you with the use of your LeCroy color digital oscilloscope.





First Steps in Measuring

First, the initial, basic steps for most measurements...

Application Setup

Connect the signal to be measured — for example, the calibrator (CAL) — to the Channel 2 BNC input (CH 2).

STEP 1

Reset: press , the top  and  simultaneously.

Then press  to turn off Trace 1, and display:

Note: At power-up the scope remains set to the last-used setup. After the Reset in Step 1 (not to be confused with use of the RESET button, which is only for ZOOM + MATH), it reverts to its default power-up settings, with both Traces 1 and 2 activated.

The traces shown depend on the previous setup and are switched on or off using the corresponding TRACE ON/OFF buttons. When CH 1 is switched off, Channel 2 alone will remain activated — as shown here.

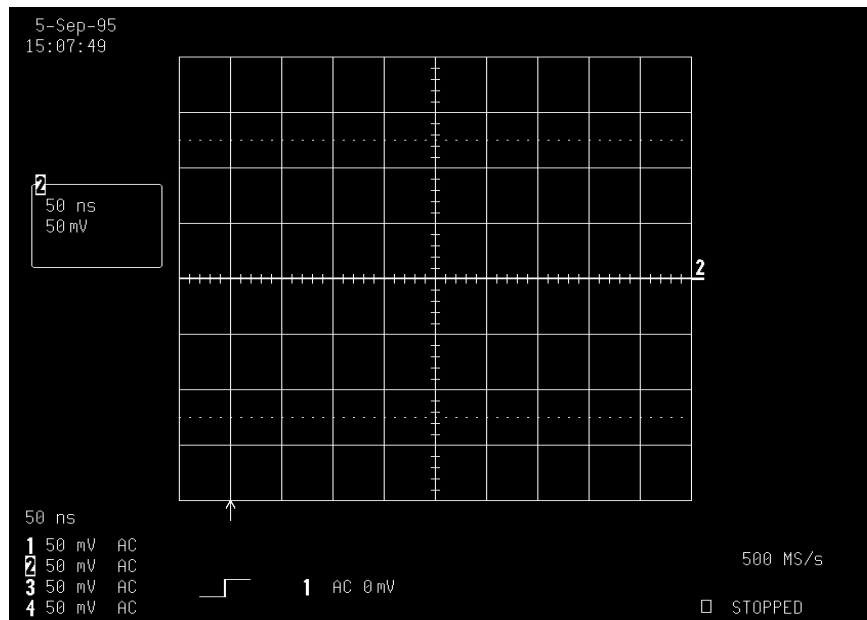

STEP 2

COUPLING
Press 

Then press the corresponding  to select from the 'Coupling' menu the coupling matching the source's impedance — 50 Ω in this case.

The screen will display:

Note: The coupling must be well adapted to avoid reflections at input to the oscilloscope. COUPLING, like most of the vertical controls, applies only to the selected channel (highlighted on-screen).

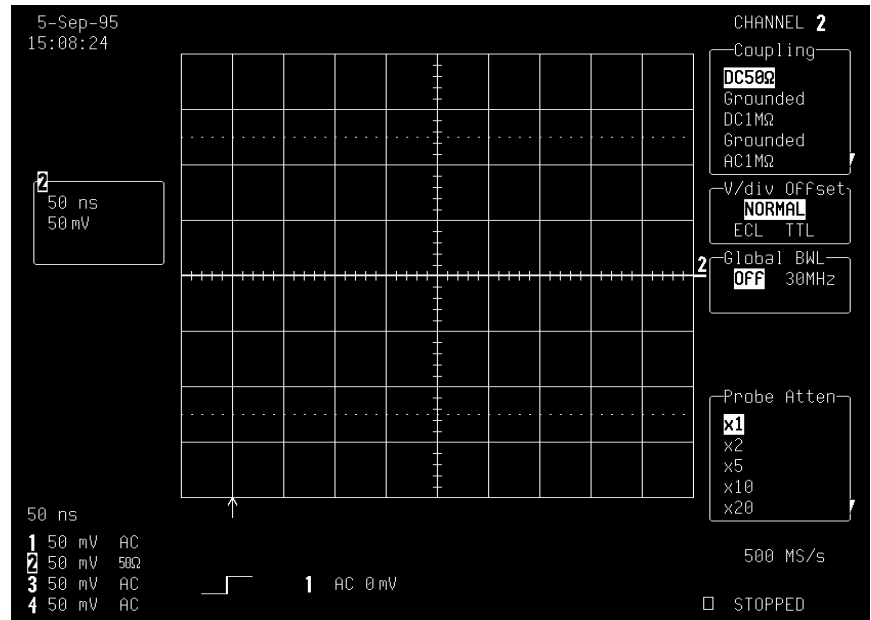



Measuring Skills

STEP 3 

**AUTO
SETUP**
Press  again.

The screen will then display:

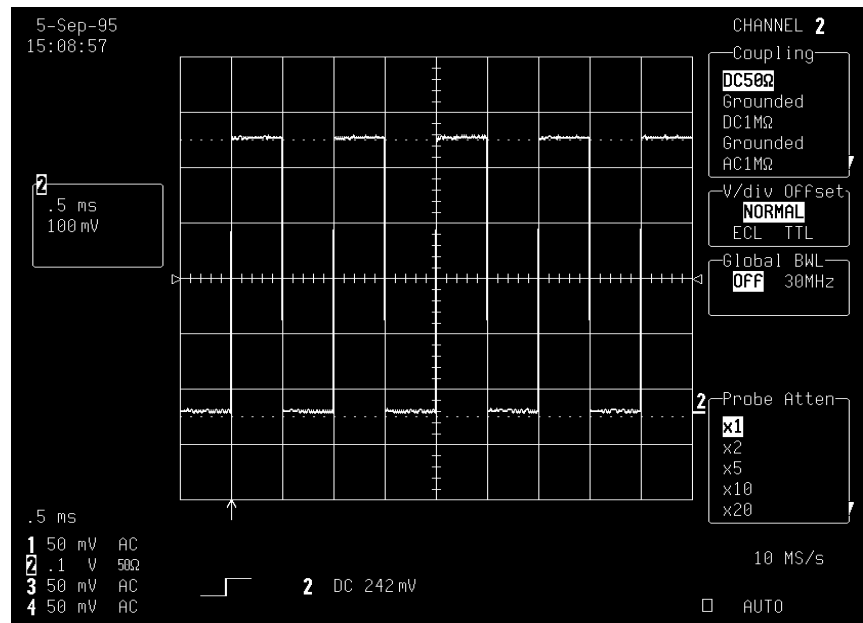

These three basic steps will be repeated as a prelude to performing most of the described measurements that follow...









Best Digitizing with All Eight Bits

The scope's eight-bit analog-to-digital converter (ADC) offers 256 levels of quantization. Acquisition on all levels gives the best digitizing: the digitized signal covers all eight screen divisions without going off-screen ('clipping'). Here's how best to digitize on all eight bits.

Application Setup

Connect the signal to be measured — a 1 MHz, 100 mV (peak-to-peak) triangle wave — to CH 2.

STEP 1 

Reset: press , the top  and  simultaneously.
Then press  to turn off Trace 1.

STEP 2 

Press , then the corresponding  to select from the "Coupling" menu the coupling matching the source's impedance — 50 Ω.

STEP 3 

Press  again.

Eight-Bit Digitizing

The screen will display:

Note: The signal's amplitude is acquired on approximately six divisions, corresponding to $5/8 = 192$ levels or 7.32 bits of quantification used.

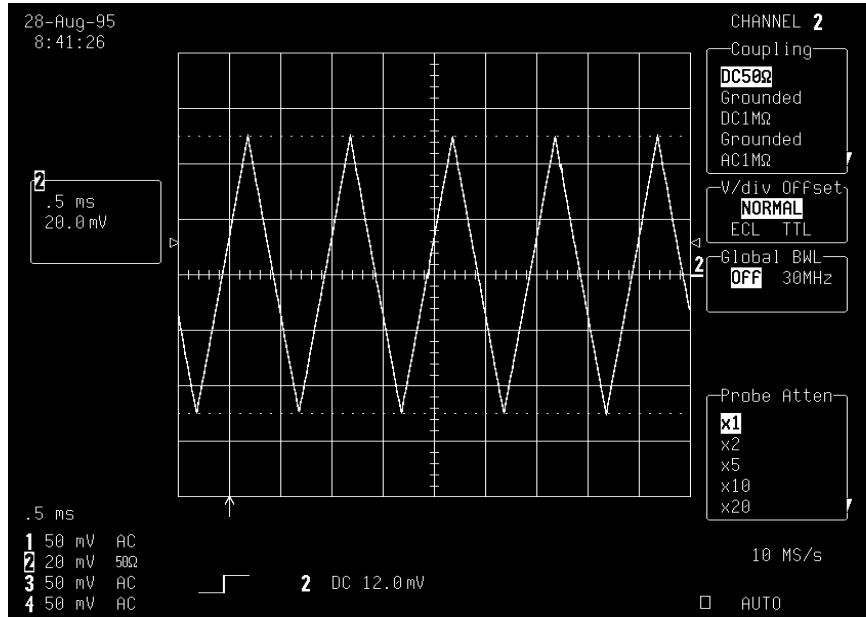

STEP 4 

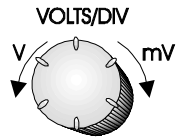

Use  to adjust the channel input sensitivity and have the signal fill all eight divisions of the screen.

And to even more finely adjust the sensitivity, press 

Tips: Changing the sensitivity using the VAR button will give a non-rounded gain — for example, 12.8 mV/DIV. Determining the amplitude of the signal by reading visually from the screen can be difficult. To avoid reading errors, use CURSORS (see Accurate Measuring with Cursors, page 3-16).



Measuring Skills

The screen will now display:

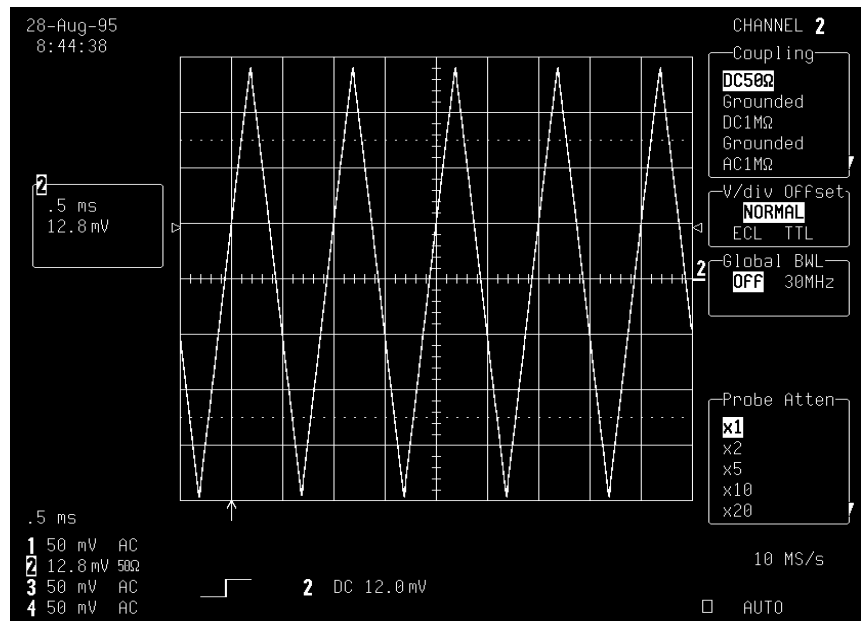

Characterizing a Pulse

A major advantage of DSOs is the capacity to accurately measure acquired data using standard parameters.

Your scope offers a selection of Voltage and Time parameters, as well as parameter customization.





This tutorial shows how standard parameters are displayed to characterize pulses vertically and horizontally. Automatic parameter measurement and statistical values thus become easily obtainable.

Application Setup

Connect the signal to be measured — for example, the CAL signal with the shape selected as “pulse (25 ns)” — to CH 1.



Measuring Skills

STEP 1  Reset: press , the top  and  simultaneously.
Then press  to turn off Trace 2.



STEP 2  Press , then the corresponding  to select from the “Coupling” menu the coupling matching the source’s impedance — 50 Ω.

STEP 3  Press  again.

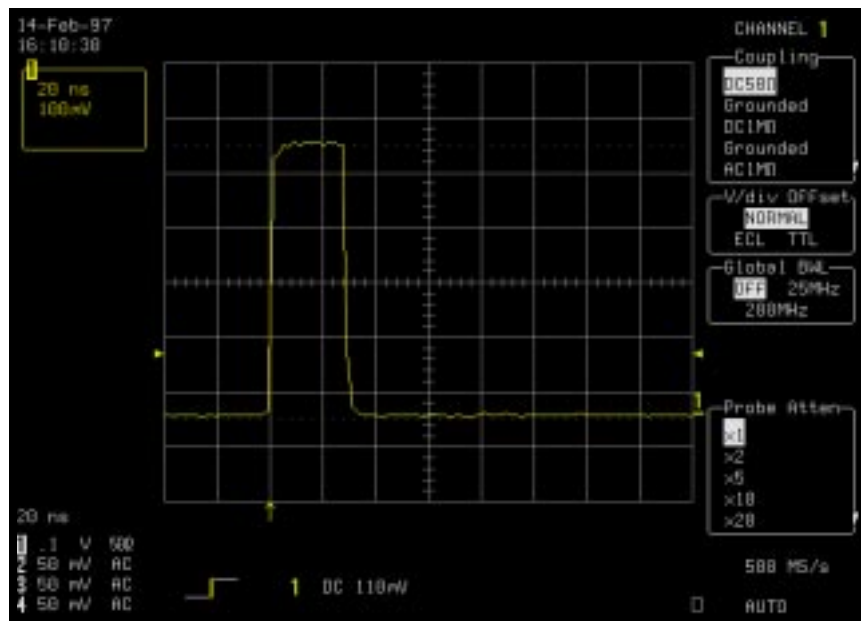
The screen will display:



Pulse Characterization

STEP 4  Press **CURSORS/ MEASURE** 

STEP 5  Then press  to select **“Parameters”**.

The screen will display:

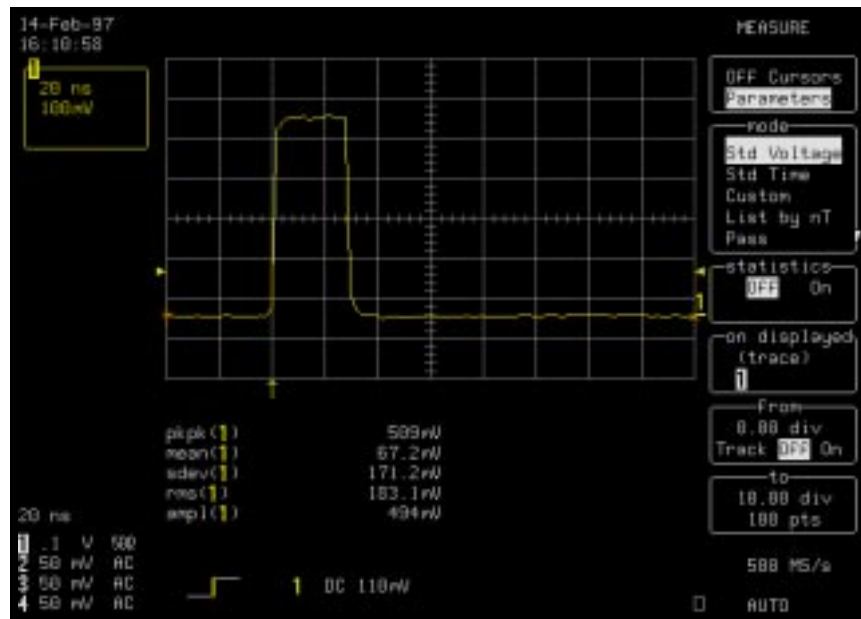

STEP 6  Next, press **SINGLE** 



The five main vertical parameters of the last acquisition, displayed beneath the grid (*see previous screen*):

pkpk	the difference between maximum and minimum data values
mean	the average of data values
sdev	the standard deviation of the data values from the mean value
rms	the square root of the sum of the squares of the data values divided by the number of points
ampl	the amplitude with noise and overshoot resistant estimator (amplitude = top base).

STEP 7

Now, press  to select “**Std Time**” from the “mode” menu.

The five main horizontal parameters of the last pulse, displayed beneath the grid (*next screen*):

period	the duration of a full cycle at 50% crossings
width	of the first <50 pulses (+ or -) in the analyzed region
rise	the transition time on the rising edge for 10–90% amplitude
fall	the transition time for the falling edge from 90%–10% amplitude
delay	the time from the trigger (or t=0) to the first 50% transition.

Pulse Characterization

Note: Acquiring just one pulse does not permit measurement of a signal period. Therefore, the period parameter is not calculated and no value is displayed.

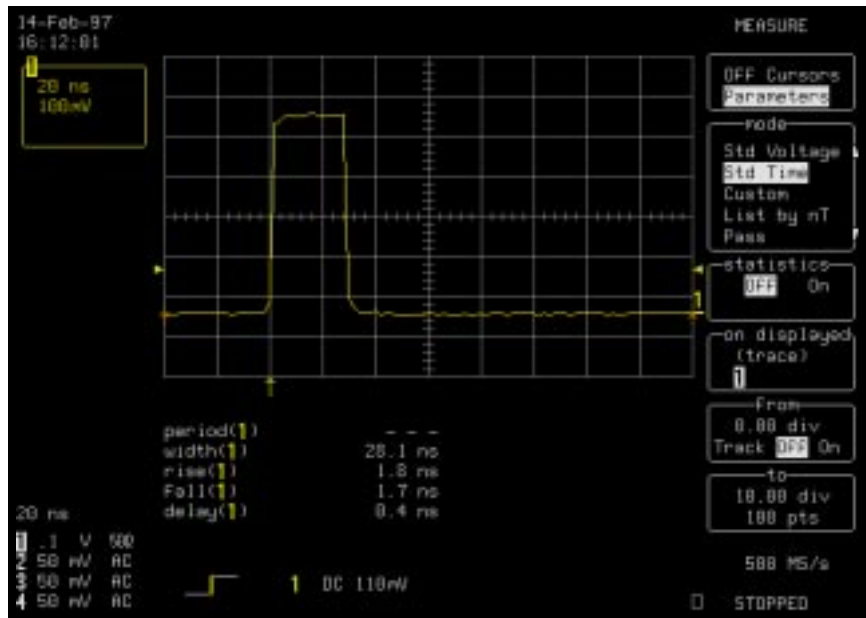

Tips: In order to perform the parameter calculation on a particular section of the signal, adjust the left and right cursors using the upper and lower knobs, respectively, on the SYSTEM SETUP part of the front panel.



Measuring Skills

On the screen below an area of interest has been selected for measuring the time of the pulse's falling edge, as indicated by "delay (1)":

Note: The number of points used to calculate the parameters is shown in the "to" menu.

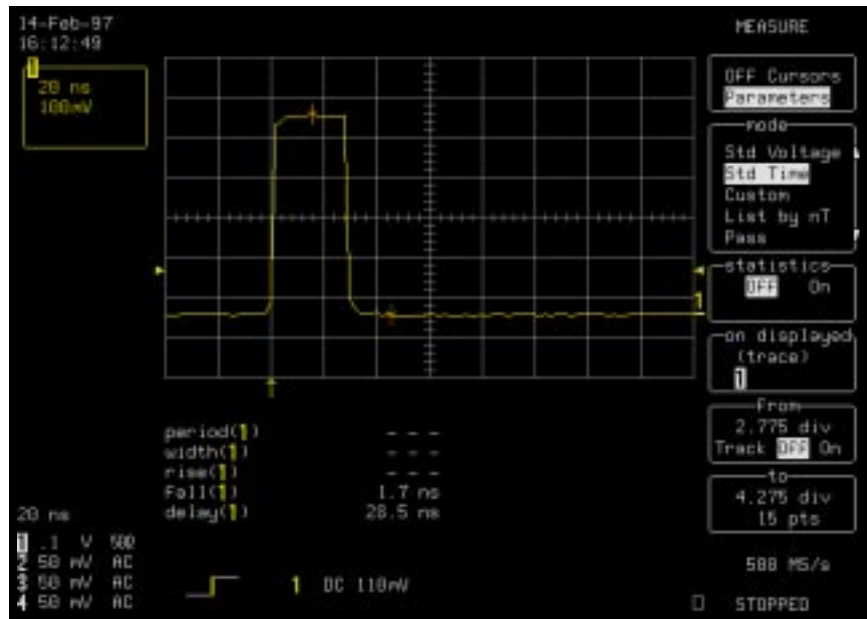

STEP 8 

Use the  to reselect the entire trace as the area of interest, as described in the **Tip** on the previous page.

STEP 9 

Then press the corresponding menu  to select "On" from the "statistics" menu.

Four different values are displayed for each parameter: average value; lowest value; highest value; and sigma, the standard deviation of the data values from the mean value. In order to be sure of the statistics obtained, you will need to perform a number of acquisitions.

Pulse Characterization

Finally, press  **NORMAL**

Note: The sweeps number shown immediately under the grid is the number of acquisitions to which the statistics calculated and displayed apply. To restart the statistics calculation, press the CLEAR SWEEPS button. Only the future acquisitions will be included in the calculation.

All these parameters are readable from a PC linked to the scope by GPIB or RS232 remote control using the "PArAmeter_VAlue?" query. Also possible, using Custom Mode, is the selection of five different parameters (even more with the WP03 package) relating to a variety of traces or memories between the available standard parameters.

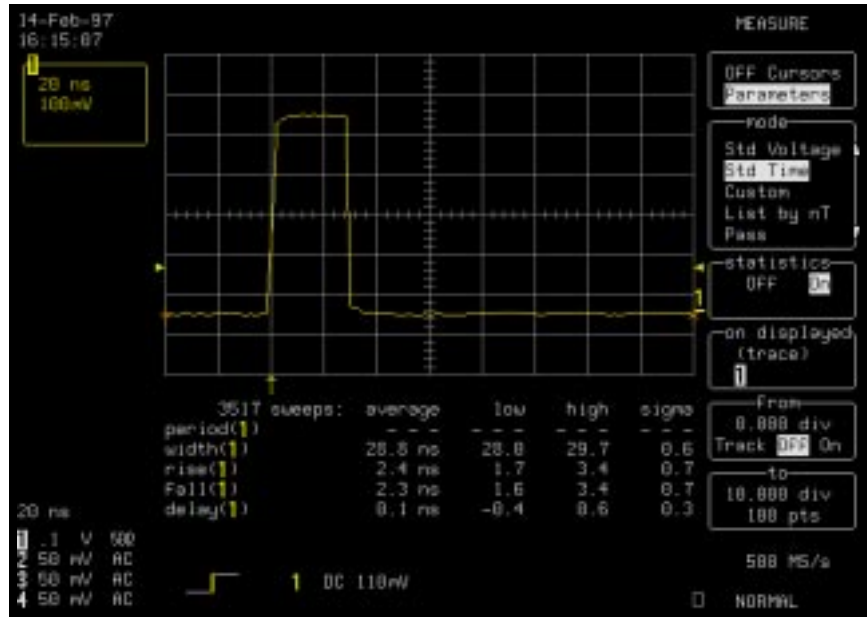



Accurate Measuring with Cursors



A variety of cursors of two basic types are used with your LeCroy color DSO. In Standard Display, Amplitude (Voltage) cursors are lines moved on the grid to measure the amplitude of a signal. And Time (Frequency) cursors are markers moved along the waveform that can be placed at a desired time to read the signal's amplitude at that time.

For details of cursor behavior in the different cursor and display modes, see the *Operator's Manual*.

Application Setup

Connect the signal to be measured — for example, the calibrator (CAL) — to CH 1.



STEP 1 

Reset: press , the top  and  simultaneously.

Then press  to turn off Trace 2.

Measuring with Cursors

STEP 2 

Press  , then the corresponding  to select from the “Coupling” menu the coupling matching the source’s impedance — 50 Ω .

STEP 3 

Press  again.

STEP 4 

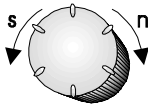
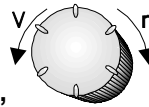
Turn  to adjust the timebase,  to fill the screen with the signal.

Press  to halt the scope and display:

Note: Pressing SINGLE is a smooth way of stopping the scope to allow measurement of the waveform captured on-screen.

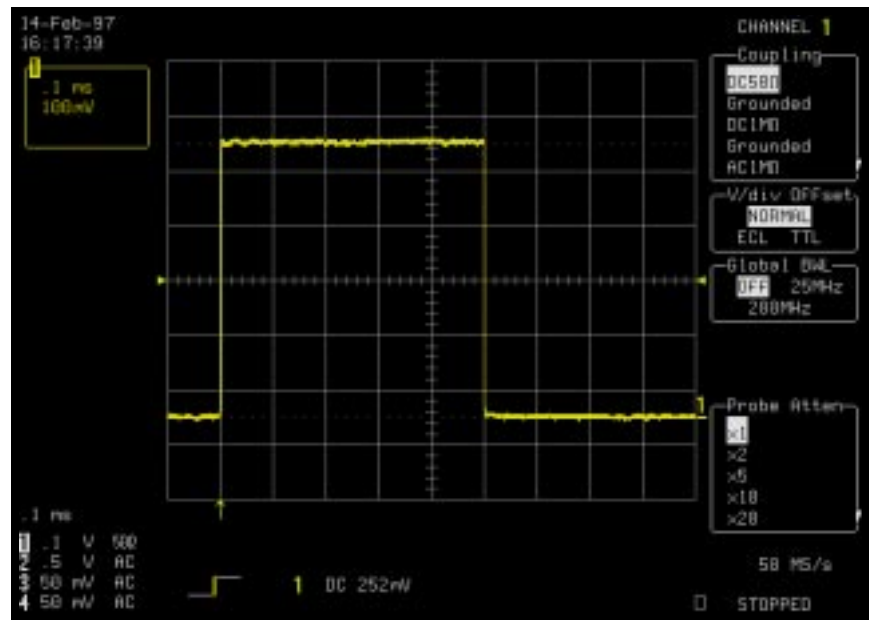





Measuring Skills

STEP 5 

CURSORS/
MEASURE
Press 

STEP 6 

Press the  to select “Cursors”.

(“Amplitude” and “Absolute” will show as the default selections in the “mode” and “type” menus, respectively.)

The screen will display:

Note: In Absolute Amplitude Mode, selected here by default, a single cursor bar in the form of a broken line is displayed (in this example shown placed at the very bottom of the grid). The vertical position of this bar on the grid can be adjusted by turning the corresponding ‘cursor’ knob. The difference in amplitude, between the cursor and the ground level indicated by the “1” at right of the grid, is shown in the trace label at top left of screen.

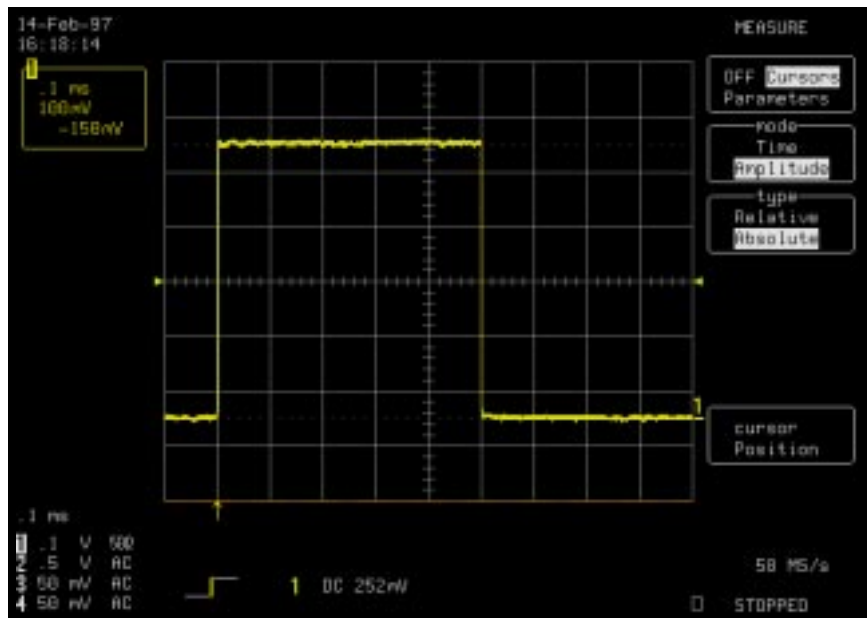

STEP 7 

Turn  corresponding to the “cursor Position” menu, to move the Absolute Amplitude cursor to the top of the signal.

Measuring with Cursors

The screen will then display:

Note: Amplitude cursors are moved pixel by pixel up and down the grid.

Here the difference in amplitude between the ground and maximum levels of the square wave has been measured and is shown in the trace label.

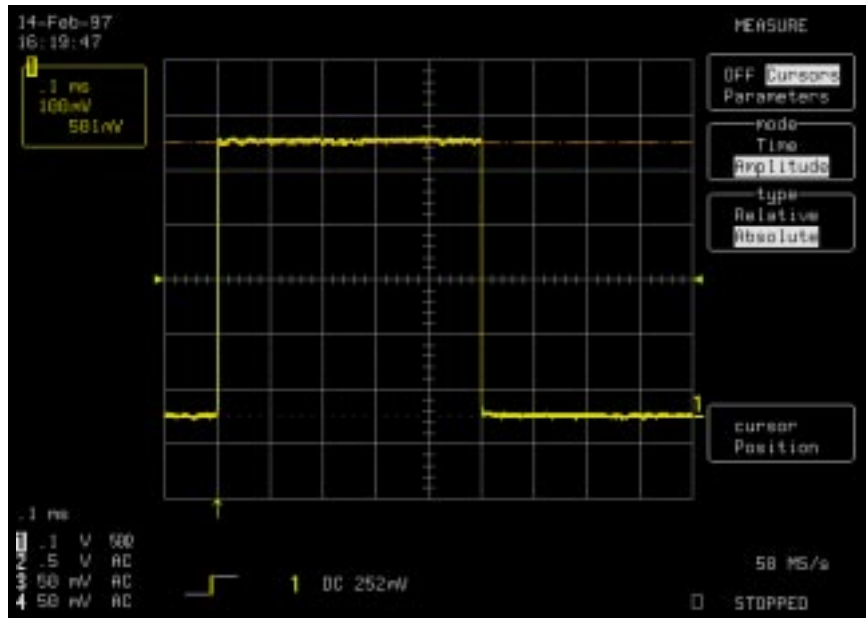

STEP 8 

Press the corresponding  to select “**Relative**” from the “type” menu. This will activate the Relative Amplitude Mode and display a pair of cursors.



Measuring Skills

The screen will display:

Note: In Relative Amplitude Mode, two bars, the reference and difference cursors, are controlled to give readings between the two in amplitude. In this example, the reference cursor, moved by turning the upper knob corresponding to the “Reference cursor” menu, has been placed on the base level of the square wave. While the difference cursor, adjusted using the lower knob and “Difference cursor” menu, has been positioned at the top of the square wave — the difference between the two in this case giving the wave’s amplitude, indicated in the trace label.

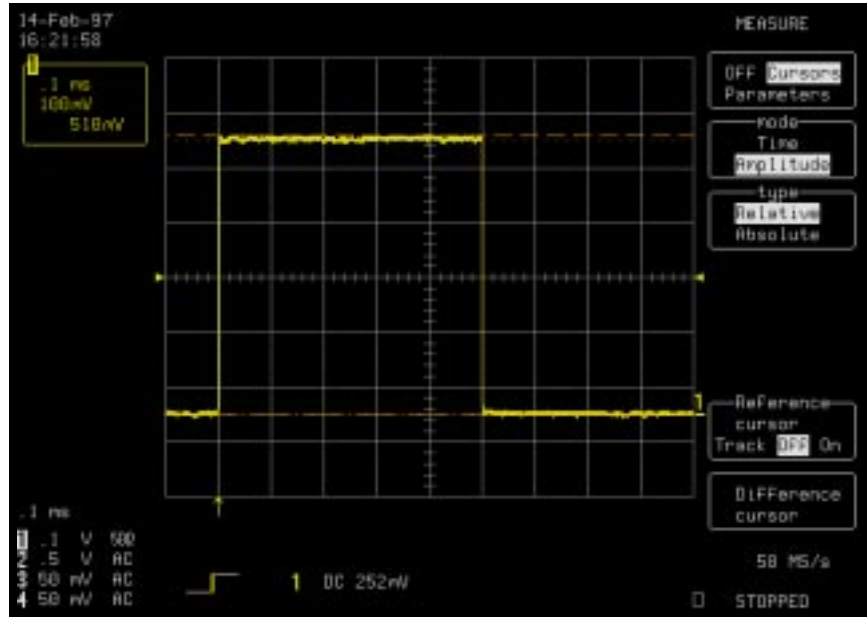

Tips: Press the corresponding menu button to select “Track On” from the “Reference cursor” menu. Now, when the reference cursor bar is moved using the upper knob the difference bar will “track” it and the two lines will move in tandem, remaining the same distance apart. However, turning the lower, “Difference cursor” knob will change the difference cursor position and the distance between the two cursors. Pressing the same menu button as before will turn off tracking.

STEP 9

Press the corresponding s to select “Time” and “Absolute” from the “mode” and “type” menus, thereby activating Absolute Time Mode.

Measuring with Cursors

The screen will then display:

Note: Time cursors are markers moved to any point along the trace and can be used to measure time and amplitude. The reference point ($t=0$) is the trigger point indicated by the vertical arrow on the grid base. When the markers are placed on a data point, they change appearance (see the Operator's Manual for a full description). The Absolute Time cursor is a cross-hair marker. Here, the cursor — highlighted to make it more visible in this example — is shown at the trigger point on the rising edge of the square wave.

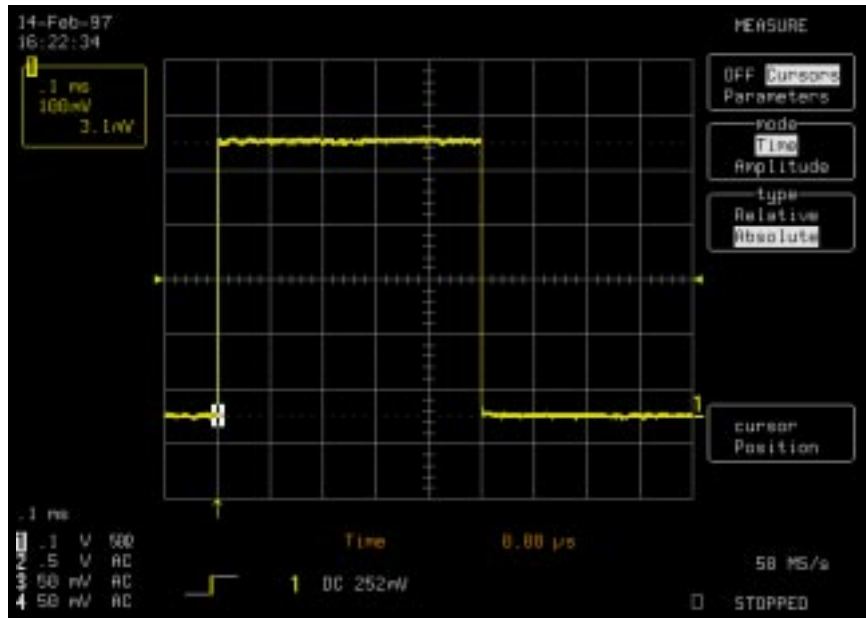

STEP 10 

Turn the  corresponding to the “cursor Position” menu to change the position of the Absolute Time cursor.



Measuring Skills

The screen will then display:

The value measured between the trigger point and the Absolute Time cursor is shown as the "Time" value directly beneath the grid. The (highlighted) cursor in this example has been moved to the falling edge of the square wave.

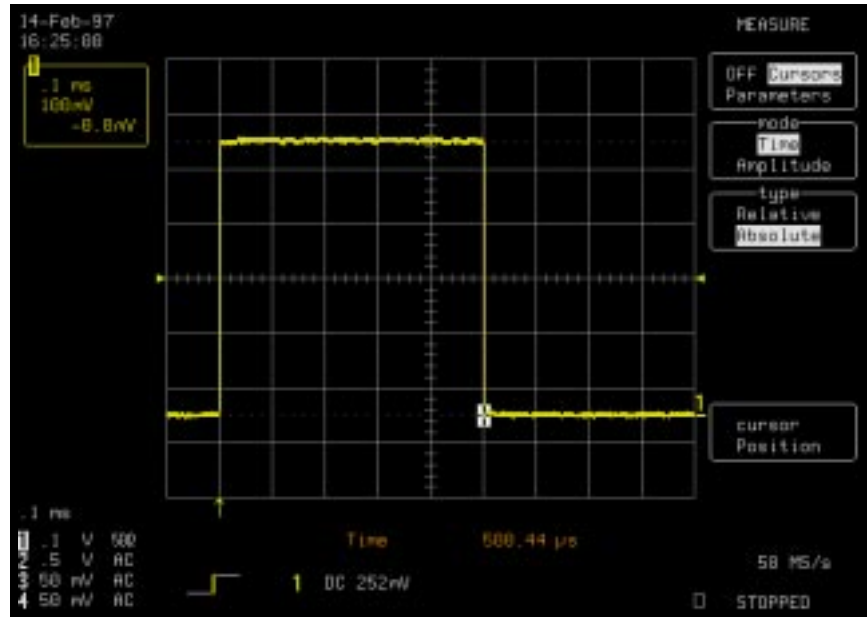

STEP 11 

Press the  to select "Relative" from the "type" menu and activate Relative Time Mode.

Measuring with Cursors

The screen will display:

Note: In Relative Time Mode the cursors are a pair of arrows that move along the waveform. In this example, the Reference and Difference cursors — upward- and downward-pointing arrows — are shown highlighted together at the rising edge of the square wave. Using the knob corresponding to its menu, either cursor can be moved independently of the other to any point on the trace. The value representing the time difference between the two will appear below the grid, while the amplitude difference appears in the trace label.

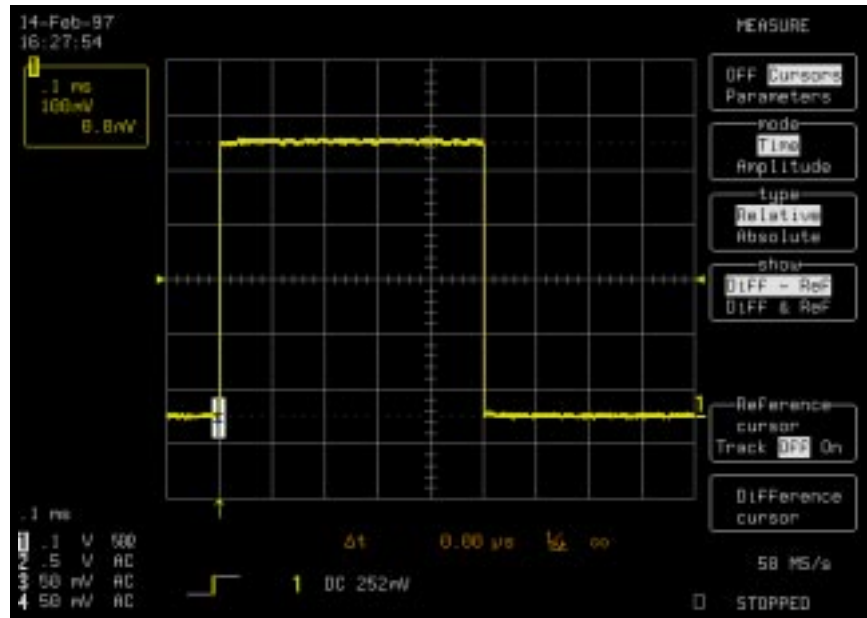



Measuring Skills

On the next screen the Relative Time cursors have been moved to illustrate how they work:

*Note: Here and in the previous screen example, the Relative Time Reference and Difference cursors are used to measure the period and frequency of the oscillations on the square wave, with the result displayed beneath the grid. The Reference cursor has been moved to the falling edge of the square wave, while the Difference cursor has been placed at the maximum level. Displayed in the trace label when “**Diff – Ref**” is selected is the gain by division and difference in amplitude between the two cursors.*

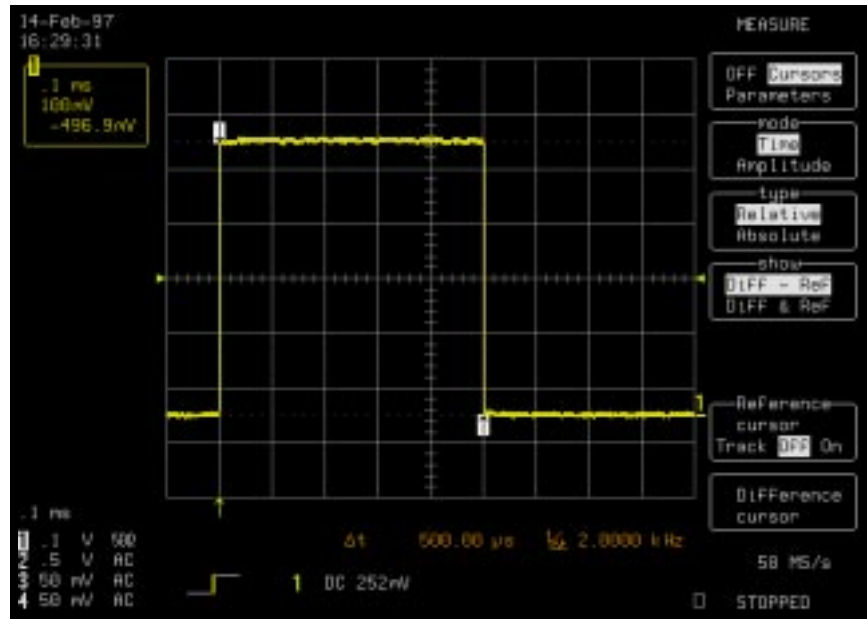

Tips: To display in the trace label each cursor's absolute amplitude relative to ground level: Press the menu button to select “**Diff & Ref**” from the “show” menu.

Measuring with Cursors

In this tutorial's final screen, "**Diff & Ref**" has been selected, displaying the amplitude values for each cursor:

Note: The absolute amplitude values of the Reference and Difference cursors are shown in the trace label respectively.

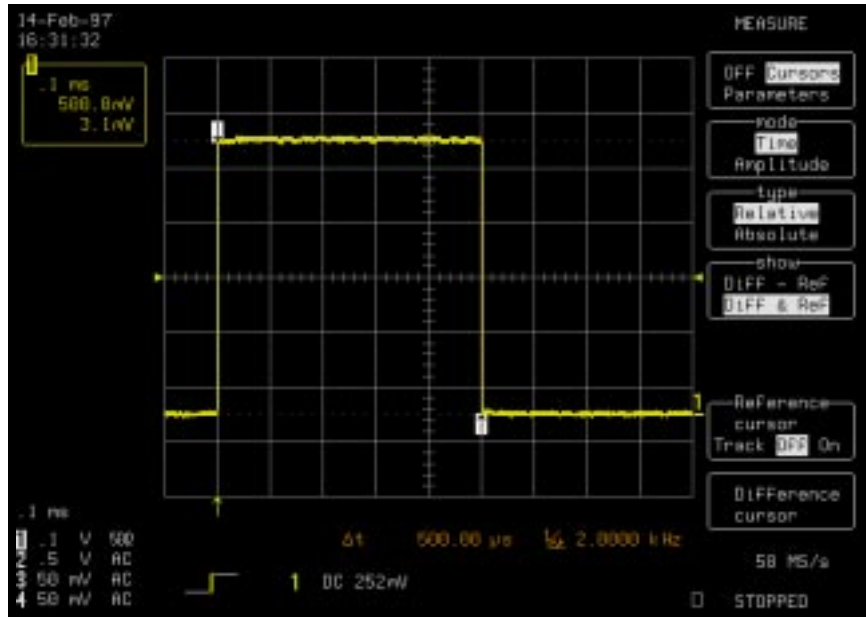



Using Average to Remove Noise

“Average” is one of the scope’s important and powerful Math functions. Use it to reduce non-systematic noise and improve the signal-to-noise ratio. Here’s how.

Application Setup



Connect the signal to be measured — a 33 kHz, 1.0 V (peak-to-peak) square wave with noise — to CH 2.

STEP 1 

Reset: press , the top  and  simultaneously.

Then press  to turn off Trace 1.

STEP 2 

Press , then the corresponding  to select from the “Coupling” menu the coupling matching the source’s impedance — 50 Ω .

STEP 3 

Press  again.

Removing Noise with Average

The screen will display:

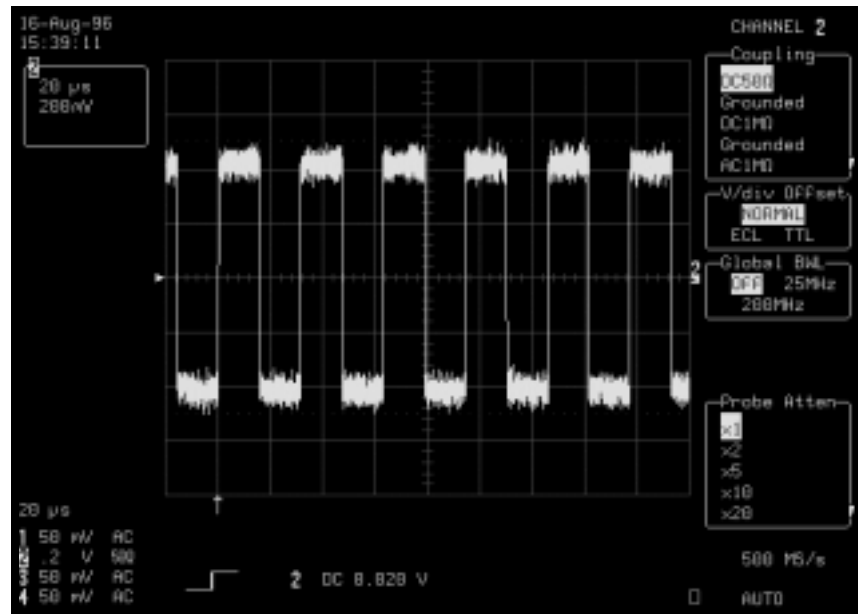

STEP 4 

Press 

STEP 5 

Press the corresponding menu  to select "Dual" from the "Grids" menu.



Measuring Skills

The screen will now display:

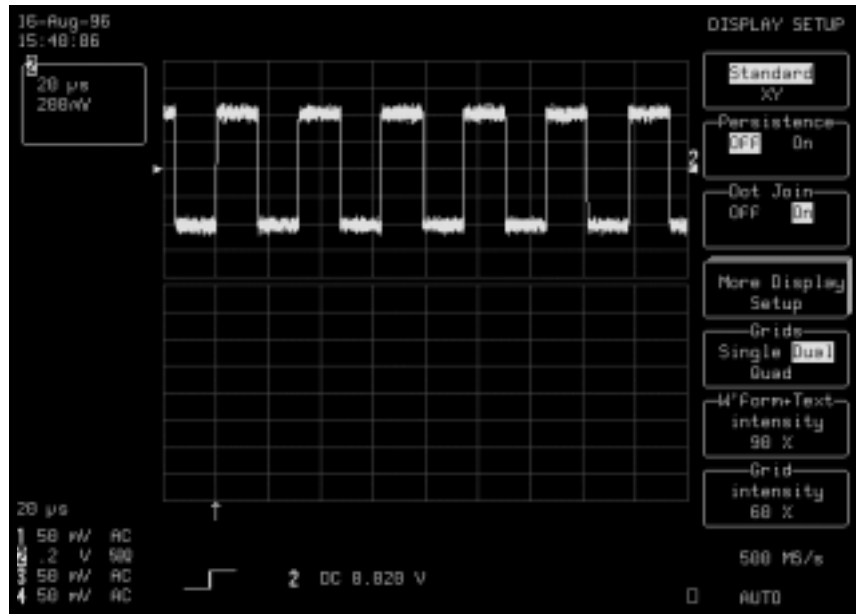

STEP 6 

Press 

STEP 7 

Press the corresponding menu  to select "REDEFINE A".

STEP 8 

Press the corresponding menu  to select "Yes" from the "use Math?" menu.

Removing Noise with Average

STEP 9 

Press the corresponding menu  to select “Average” from the “Math Type” menu.

STEP 10 

Now, press  to turn on Trace A.

The screen will display:

Note: A choice of types of acquired signal averaging is available on the “Avg Type” menu. The summed average gives all averaged data the same weight. While the continuous average can be set up to give data different weights—for example, the most recent acquisition could be given greater importance in the average calculation ratio defined by the user.

The desired number of sweeps—acquisitions taken into account in the averaging—can also be selected using the corresponding menu button. Here: an average of 1000 acquisitions is selected from the “for” menu. Any trace can be averaged: CH 1, CH 2, CH 3 or CH 4; Trace A, B, C, or D, or Memory 1, 2,3 or 4.

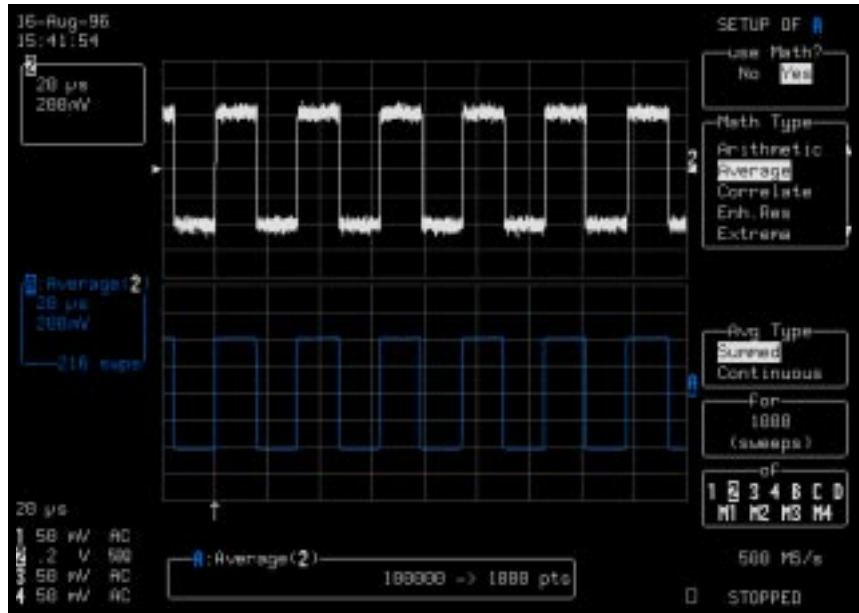

CLEAR
SWEEPS

And  (SYSTEM SETUP) to restart Averaging.



Measuring Skills

The last screen shows the final result of the averaging of 1000 acquisitions. Non-systematic noise has been greatly reduced, as can be seen from a comparison of a single CH 2 acquisition with the 1000-acquisition averaged result on Trace A.

Note: With Trace A on, the sweep counter in the Trace A label at mid-left of screen will mount until the number of sweeps reaches that selected. In the meantime, the intermediate result of the average is displayed ("216 swps", as shown on the previous page). Once the selected sweeps number is reached, calculation stops and the final result of the average is displayed, as here.

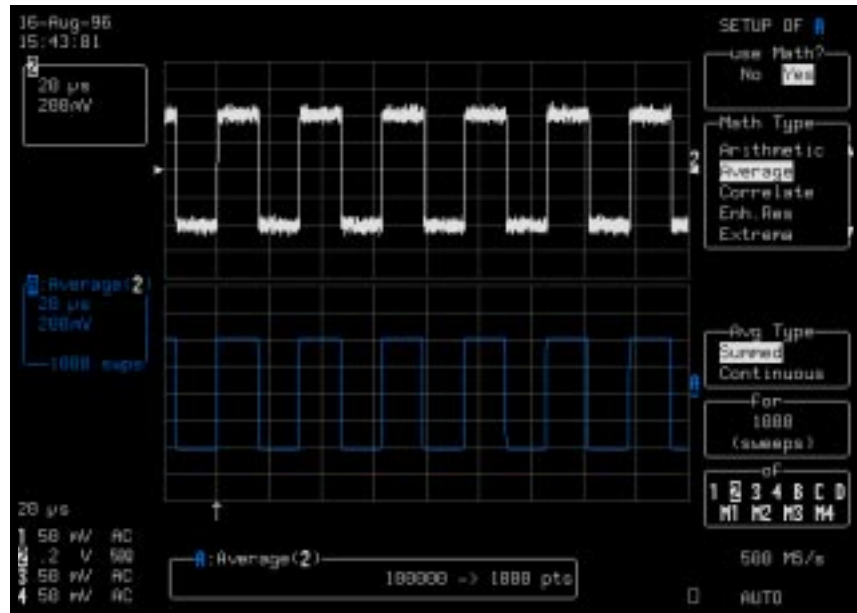





3-D Viewing with Analog Persistence

Using persistence to accumulate on-screen points from numerous acquisitions makes it easier to view signal changes over time. But Analog Persistence™, with intensity grading, makes this even easier by signifying the most frequent signal path ‘three-dimensionally’. Here’s how to use this unique feature to reveal the AM modulation of a sinewave.

Application Setup



Connect signal to be measured — an AM modulation of a 2 MHz sinewave with 100 kHz squarewave — to CH 2.

STEP 1 

Reset: press , the top  and  simultaneously.

Then press  to turn off Trace 1.

STEP 2 

Press , then the corresponding  to select from the “Coupling” menu the coupling matching the source’s impedance — 50 Ω.

STEP 3 

Press  again.



Measuring Skills

The screen will display:

Note: The AM modulation signal has a stable trigger. However, in the final periods the signal shows a number of jumps. Without LeCroy's unique Analog Persistence feature, it's not easy to characterize these modulation variations in the normal display mode.

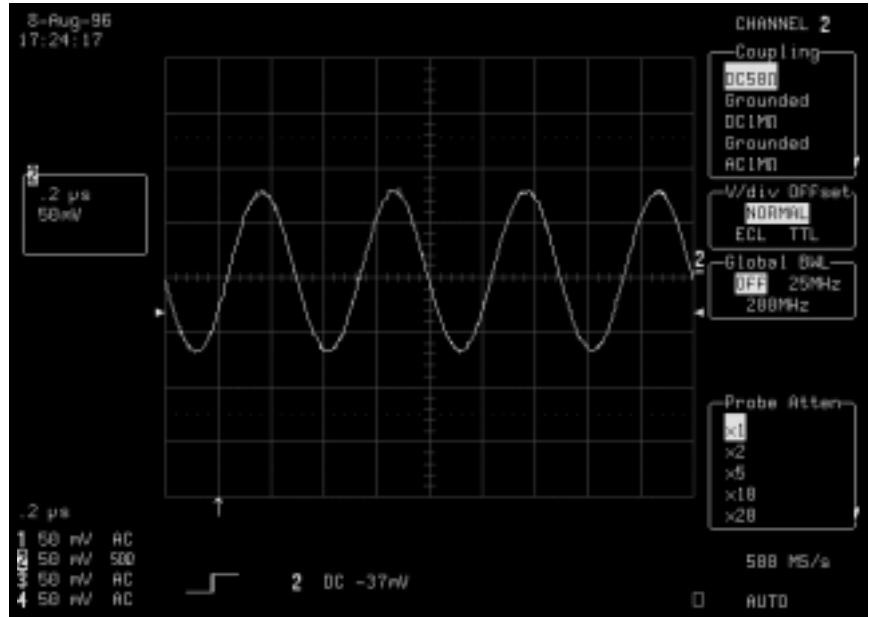

STEP 4 

Now press 

Analog Persistence

The screen will then display:

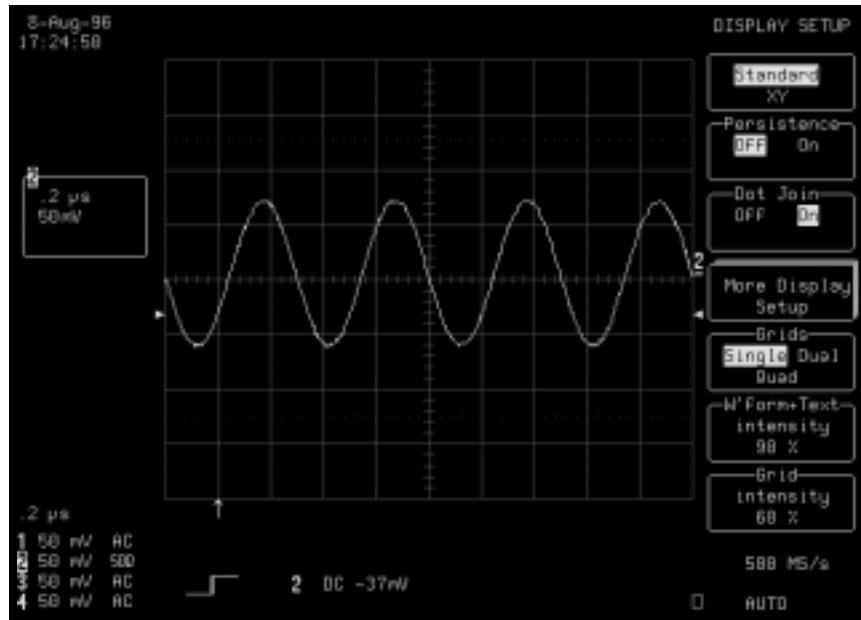

STEP 5



Press





Measuring Skills

The screen will display:

Note: Modulation time variations appear clearly in Persistence Mode. Because its source is a squarewave signal, the modulation shown here has different states. The number of acquisitions included in the display (up to one million) is shown beneath the trace label.

In this example, 1939 sweeps have been captured in a short delay to obtain the result displayed. The most recent sweep is shown as a bright vector trace.

The Analog Persistence feature is also available in XY and Sequence Modes.

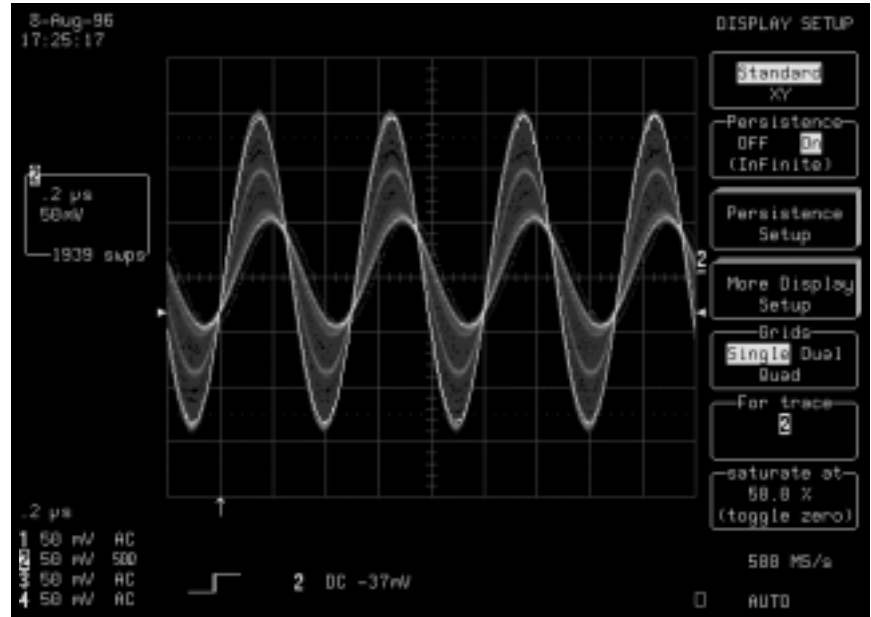

STEP 6

Press the for "Persistence Setup".

Analog Persistence

The screen will then display:

Note: The “Persist” menu offers the means to apply persistence to all displayed traces, or merely the top two, when more than one trace is displayed. Information on each trace will be shown in its respective trace label at left of screen. When “Top 2” is highlighted in the menu, this relates to the first- and second-from-top labels that will appear with each additional trace — very useful when four traces or functions are shown on-screen and persistence will not be applied to all.

The “Persist for” menu offers a choice of persistence duration in seconds. If the duration is set — for example — at one second, each acquired trace will be displayed for a second and then deleted.

The default value for this menu is “Infinite”.

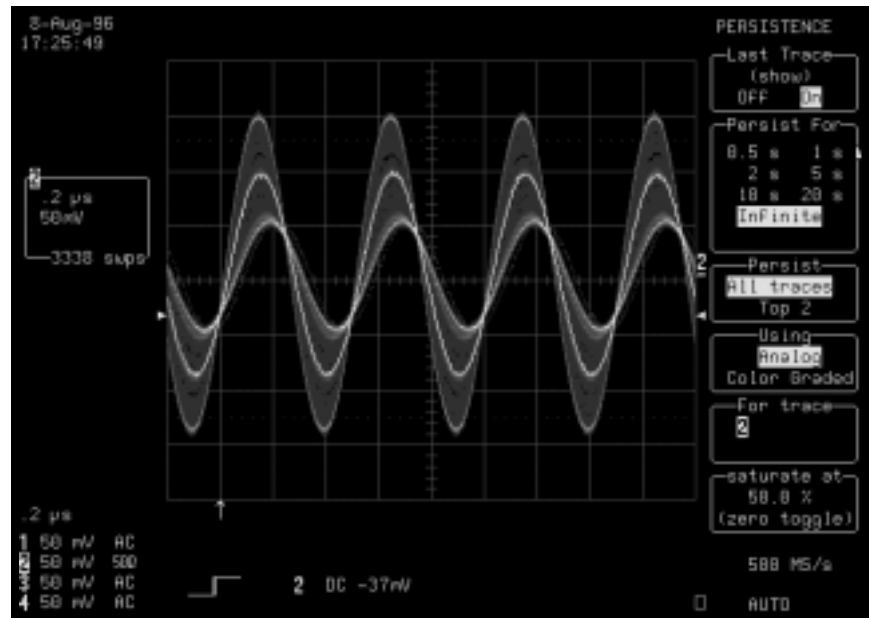

Tips: Persistence Mode can be cleared and reset manually by pressing the CLEAR SWEEPS button, or by changing any acquisition or waveform processing condition.



Measuring Skills

STEP 7

Then turn the lower 'menu'  to adjust the value of the saturation to 10 %.

The screen will display:

Note: The image displayed shows the changes in the sample event over time. Statistical integrity is preserved because the decay is proportional to the persistence population for each amplitude or time combination in the data. The brightness level of a single color is used to denote signal intensity. Particular populations are given distinguishing shades of color. These are dynamically updated as data from new acquisitions are accumulated. Population distributions in rare events can be highlighted by additional saturation, as illustrated in the screen at right.

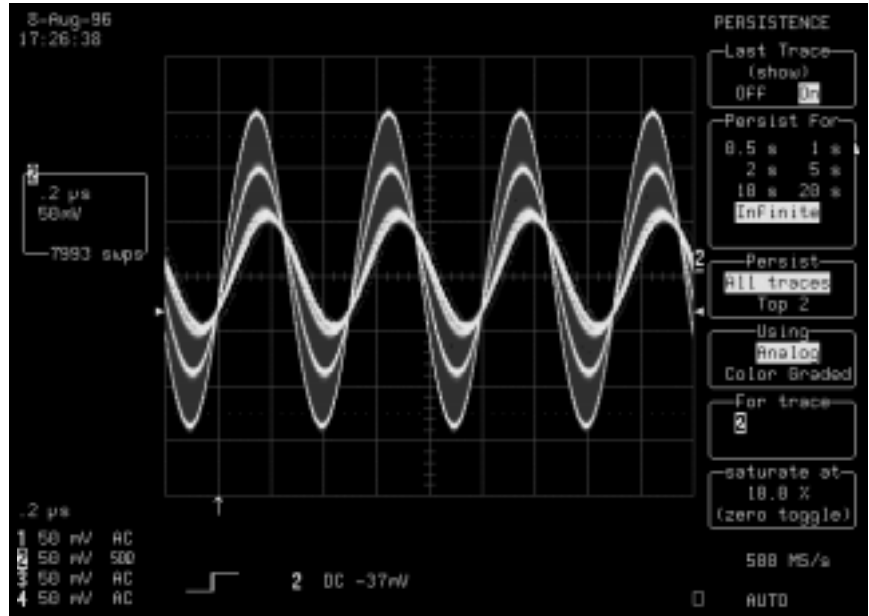

Analog Persistence

STEP 8

Press the corresponding menu  to select “Off” from the “Last Trace (show)” menu.

The screen will display:

Note: By default, the most recent sweep is shown as a bright vector trace on top of the persistence display. This menu allows to show or not the last trace on top of the persistence.

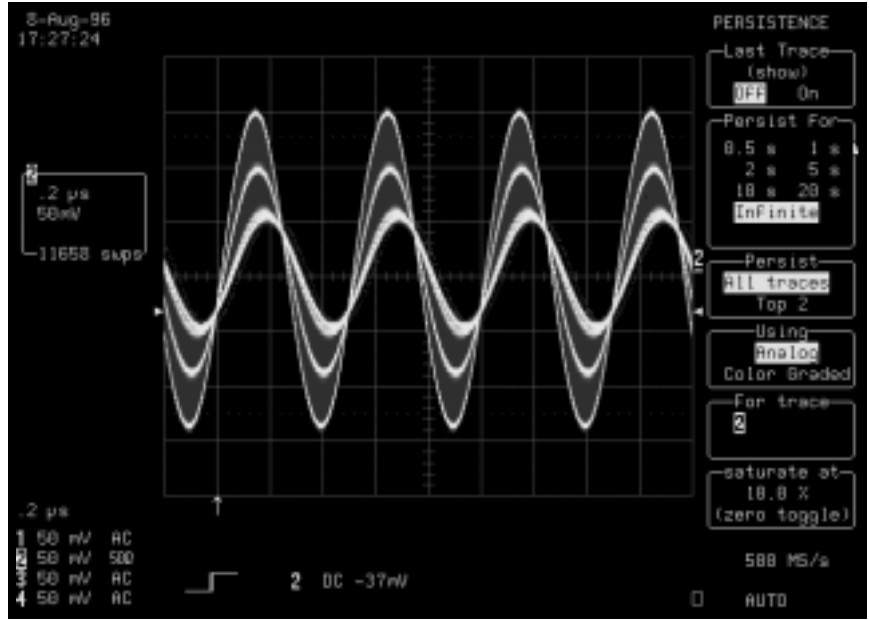



STEP 9

Press the corresponding  to select “Color Graded” from the “Using” menu.

The screen now displays:

Note: Instead of the brightness of a single color as used by the Analog Persistence feature, Color Graded Persistence uses a color spectrum from red through violet to map signal intensity, as shown in this example.

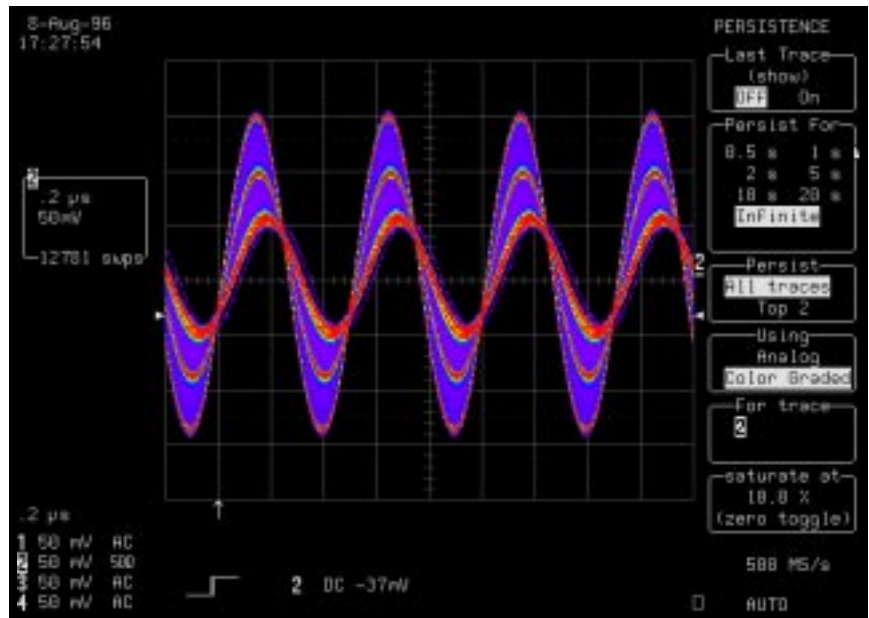

* As this guide is printed in black & white only, references are to monochrome renditions of the colors evident on your screen.



Colors that Link and Distinguish

The scope's powerful and intelligent use of color strongly links displayed waveforms and their data. This color association simplifies the viewing of information — especially in analysis of related signals or signal parts. Here's how color association handles multiple long-waveform zooms (*see also* Calculating on Long Waveforms).

Application Setup



Connect the signal to be measured — which can be a waveform of one million points or more — to CH 2.*

STEP 1 

Reset: press , the top  and  simultaneously.

Then press  to turn off Trace 1.

STEP 2 

Press , then the corresponding  to select from the "Coupling" menu the coupling matching the source's impedance — 50 Ω .

* Acquisitions of up to eight million points can be made, depending on the scope model.



Measuring Skills

STEP 3  Press  again.

STEP 4  Press  to stop the acquisition. Then  to access the “TIMEBASE” menu.

Shown at the top of the TIMEBASE menu on the following screen is the number of points acquired — 50 000 samples in this example. At the same time, the “Record up to” menu displays the acquired sample limit set by the user — “50k”.

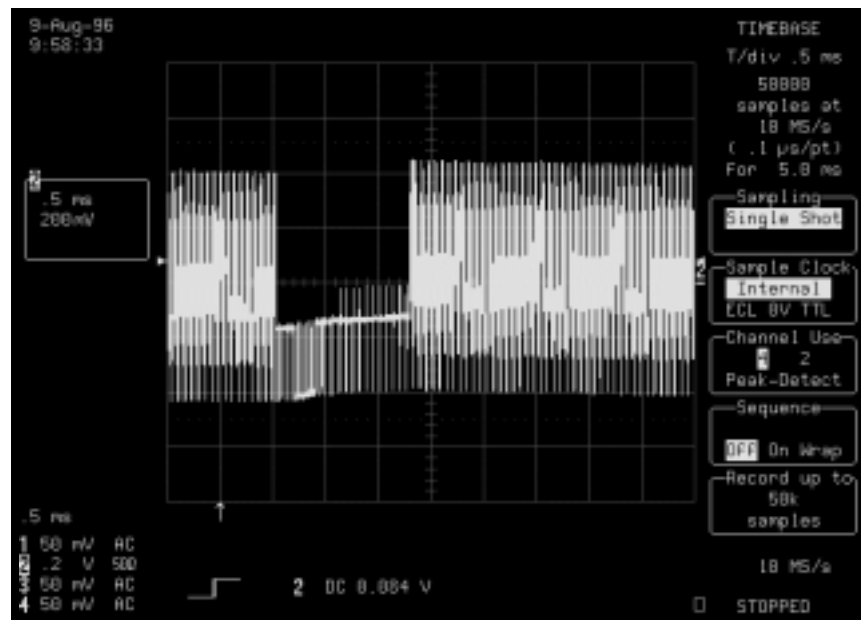

Color Association

STEP 5

Turn the lower 'menu'  so that the "Record up to" number of samples is set to at least "1M" points — for this example it is set to "2M".

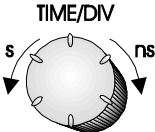

Turn  in order to slow down the timebase, and obtain more time per division, until the number of acquired points displayed is the same as in this example — "2M" points.

SINGLE

Press  to perform a single two-million-point acquisition and display:

Note: With the long acquisition memory, the maximum sampling rate is maintained at many more timebase settings than are possible with short-memory scopes. Particular advantages include:

- greater waveform detail
- high zoom factor
- protection against aliasing
- improved time resolution
- wider frequency spectrum.

(See LeCroy's Application Note ITI 008 for details).

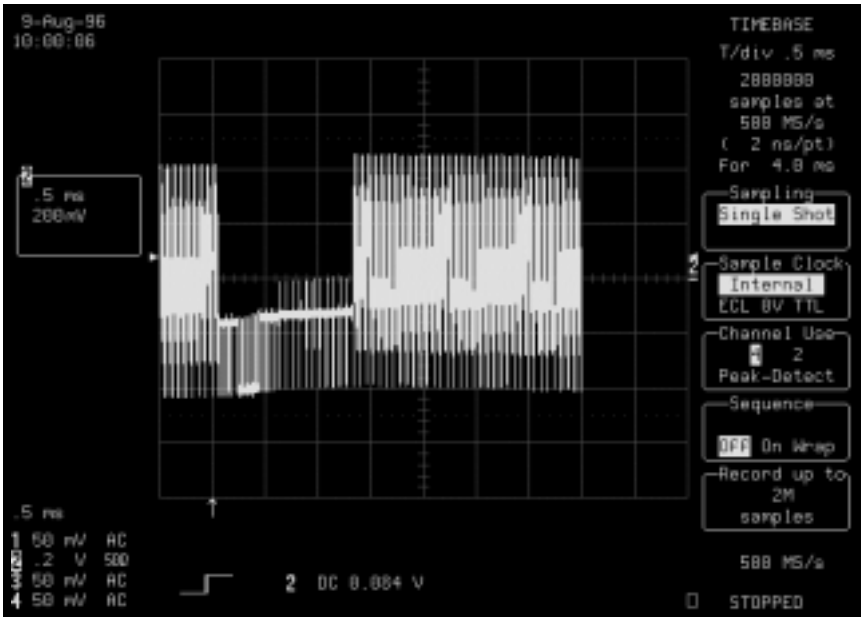



Measuring Skills

The following steps directly illustrate the extreme practicality of the color association system, as different parts of an acquired signal are simultaneously expanded and viewed.

STEP 6 

Press  to make appear the “DISPLAY SETUP” group of menus.

Then  to select “Quad” from the “Grids” menu.

The screen will display:

Note: Functions or zooms can be selected on any channel or trace. The scope allows display of four different traces in as many grids, while preserving eight-bit resolution.

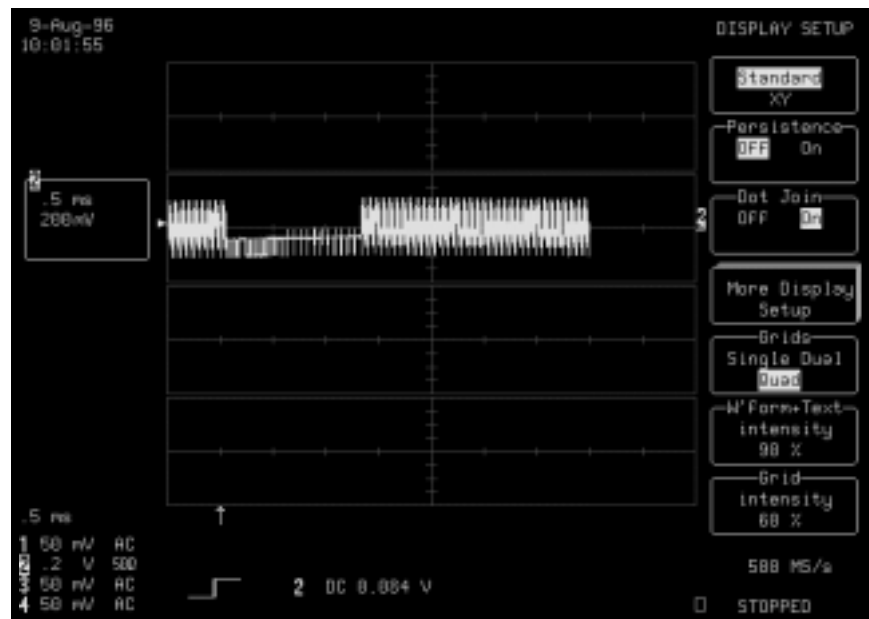

STEP 7 

Now, press 

Color Association

STEP 8 

Press the corresponding menu  for "REDEFINE A".

Next, turn the lower menu  to select "2".



Then press  to turn on Trace A.

The screen will display:

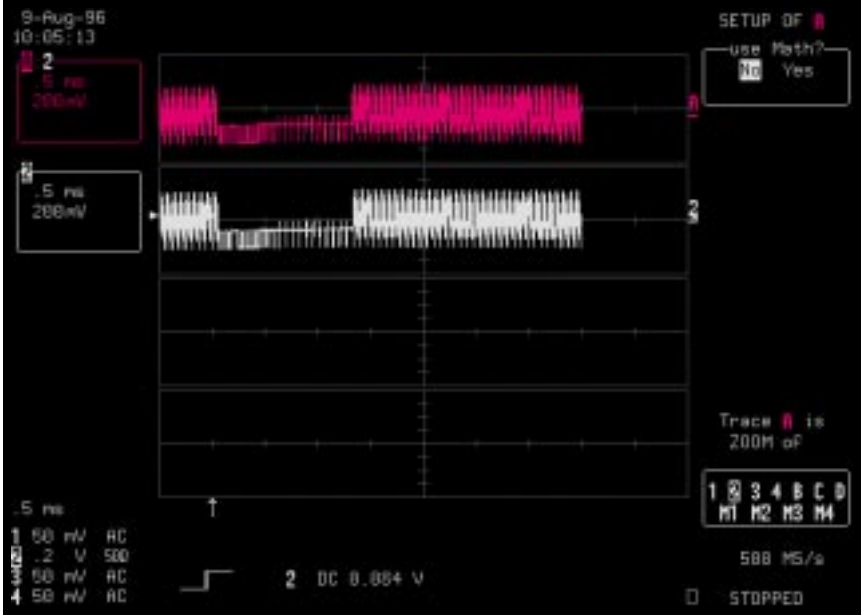
Note: After Step 8 has been taken, Trace A will be displayed as the zoom ("use Math?" "No") of CH 2, as indicated in the "Trace A is ZOOM of" menu ("2").

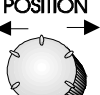

STEP 9 

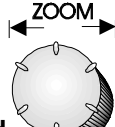
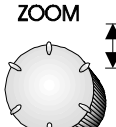
Use  with **POSITION** and  with **POSITION** and  with **ZOOM** and  with **ZOOM** to make the original signal selection, and select the timebase (horizontal zoom) with amplitude (vertical zoom). This allows the selection of a part of the original signal and the part's vertical or horizontal expansion.



Measuring Skills

The screen will then display a 10x zoom of CH 2 that indicates a zone of interest:

Note: The selected section is shown on the original trace as reinforced video. The RESET button cancels all the zoom changes and redisplay the original trace.

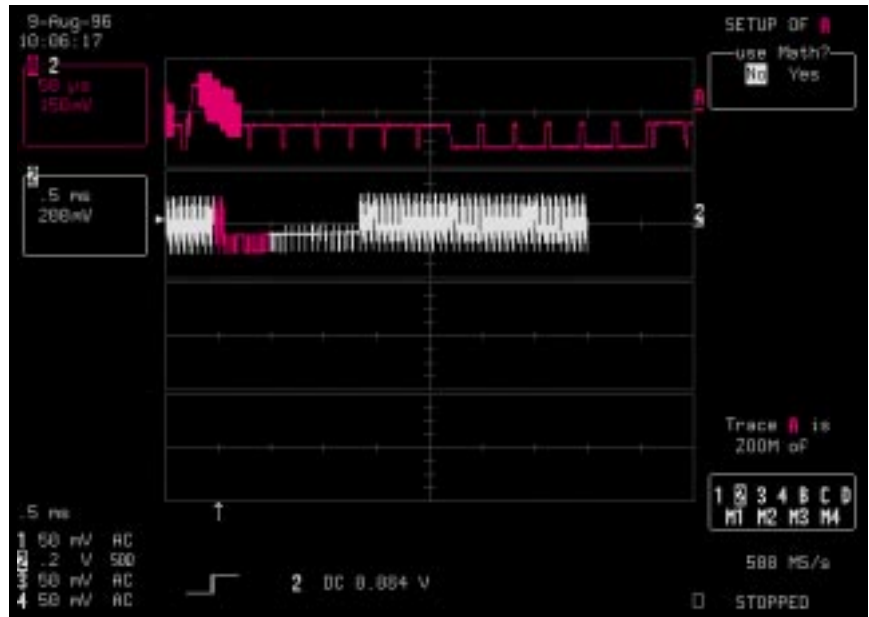



STEP 10

Repeat Steps 8 and 9, this time turning on Traces B and C to zoom other parts of CH 2.

Color Association

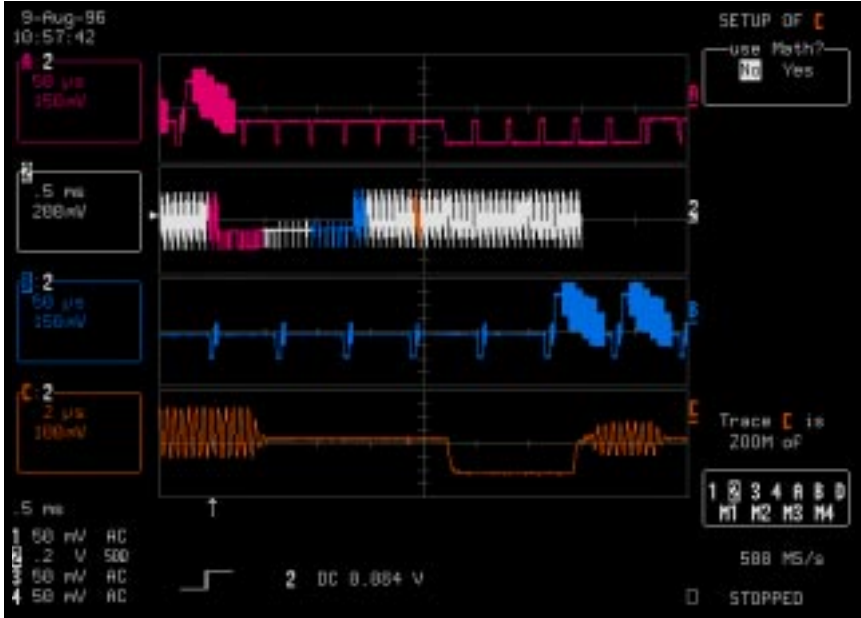
The screen will display:



STEP 11 → 

Then **FULL SCREEN** and **RETURN** to display the four grids in Full Screen mode without menus.



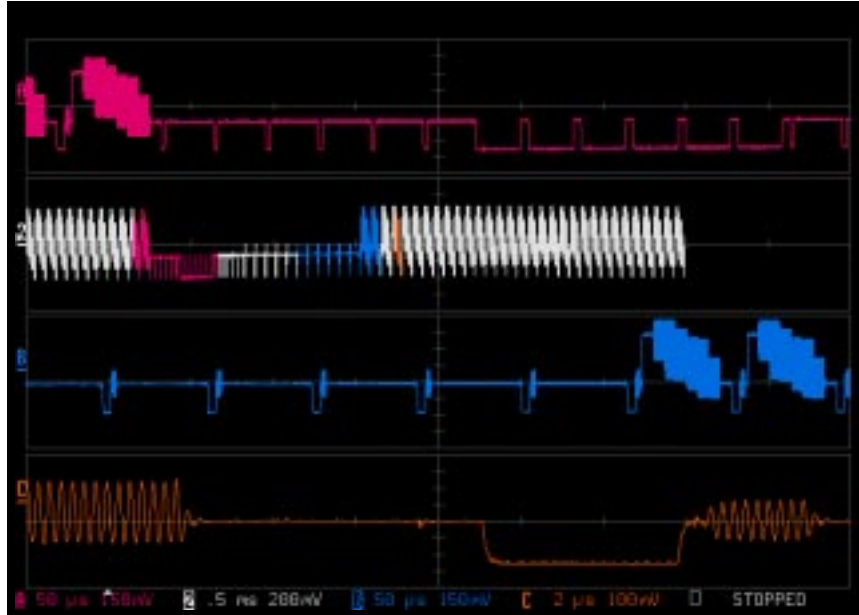

Measuring Skills

The screen will display:



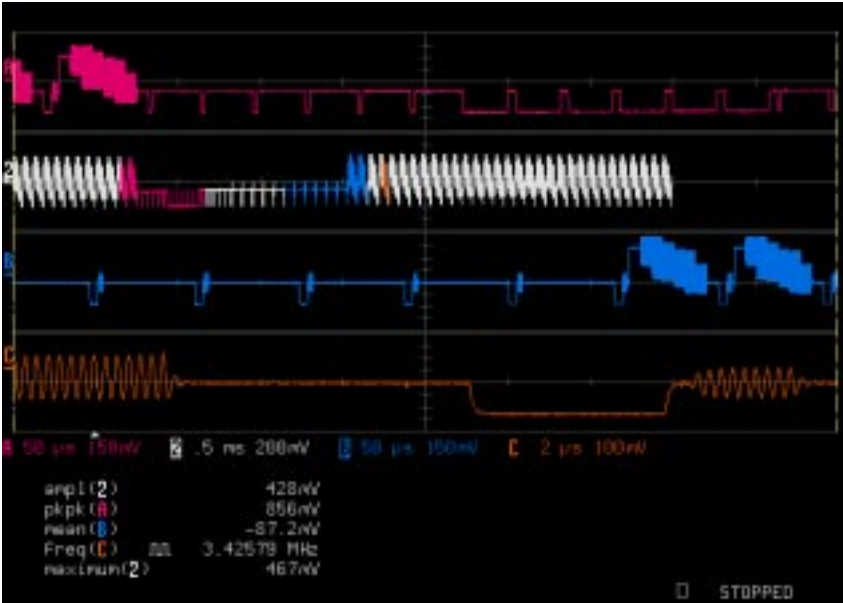

Tips: As shown on the next screen, each of the four grids can be shown with its own trace and parameters — up to five at once — simultaneously.



STEP 12 

Press 

And then the  to select “More Display Setup” from “DISPLAY SETUP”.

STEP 13 

Next, press the  to select one of the pre-set numbered color schemes from “Color Scheme”.



Measuring Skills

In this example, “Color Scheme” “5” has been selected:

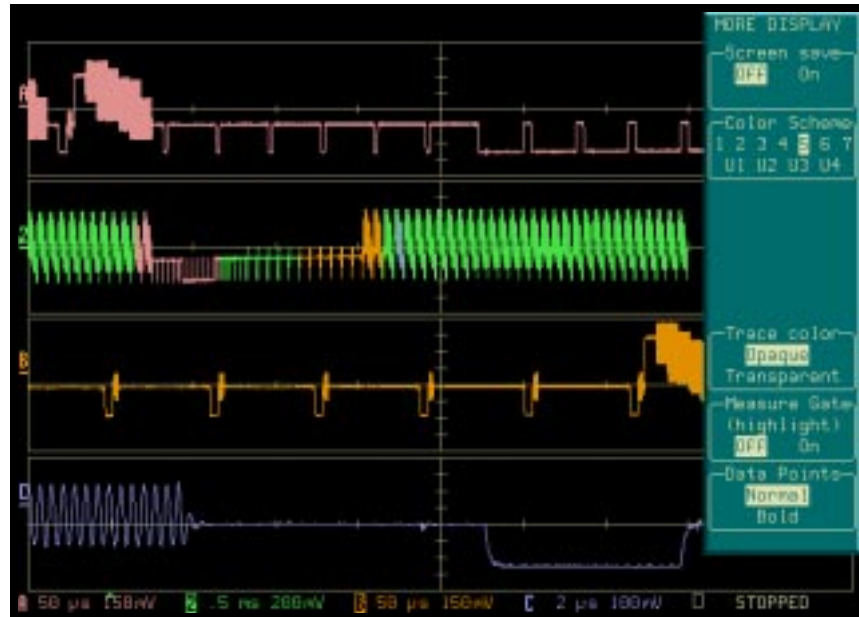

STEP 14

Now, press the  to select “U1” from “Color Scheme”. This allows the creation of a custom color palette.

Tips: Copy preset schemes to user palettes. These can then act as references and form the bases for choosing object colors in new customized color schemes.

Color Association

The screen will display:

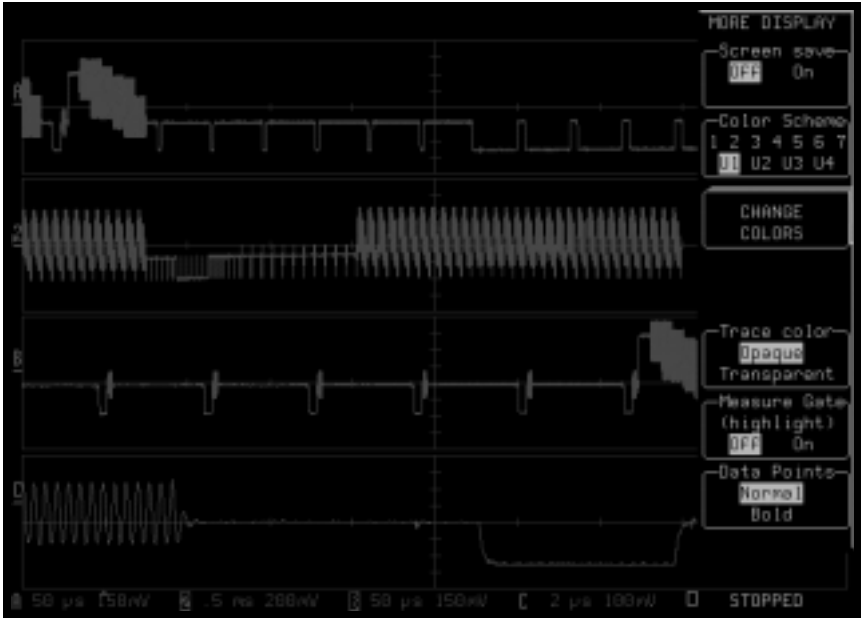

STEP 15 

Now, press the  for “CHANGE COLORS”, and then for “COPY SCHEME 1 to U1”.

The colors assigned to the objects in “U1” will now be the same as those of the pre-set “1”.

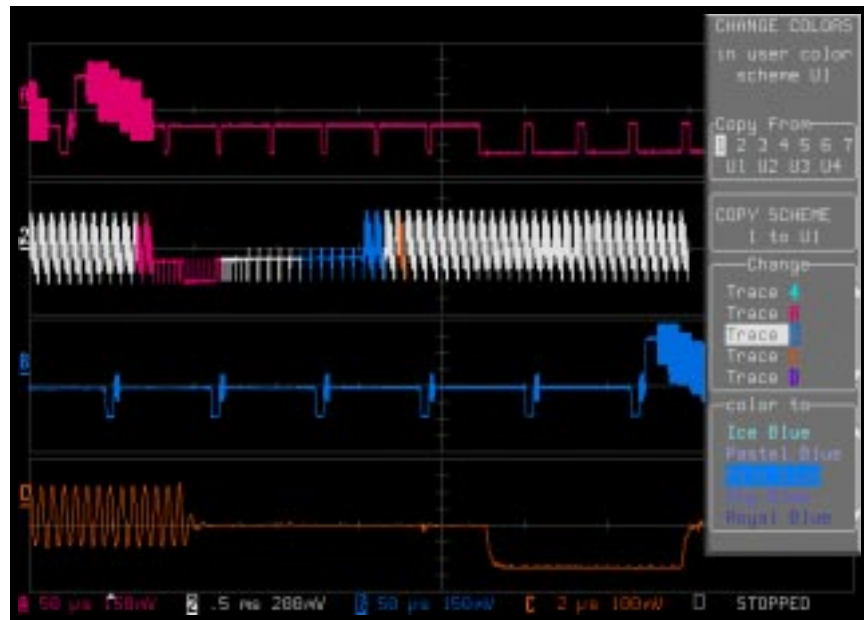

STEP 16

Next, press a  to select an object for color change. Here, Trace B is selected.

And then a  to select the color of the object selected. "Grass Green" has been selected to replace "Pale Blue" in the following example.

Color Association

The screen will display:

Note: See the Operator's Manual for a description of the displayed objects whose colors can be modified.

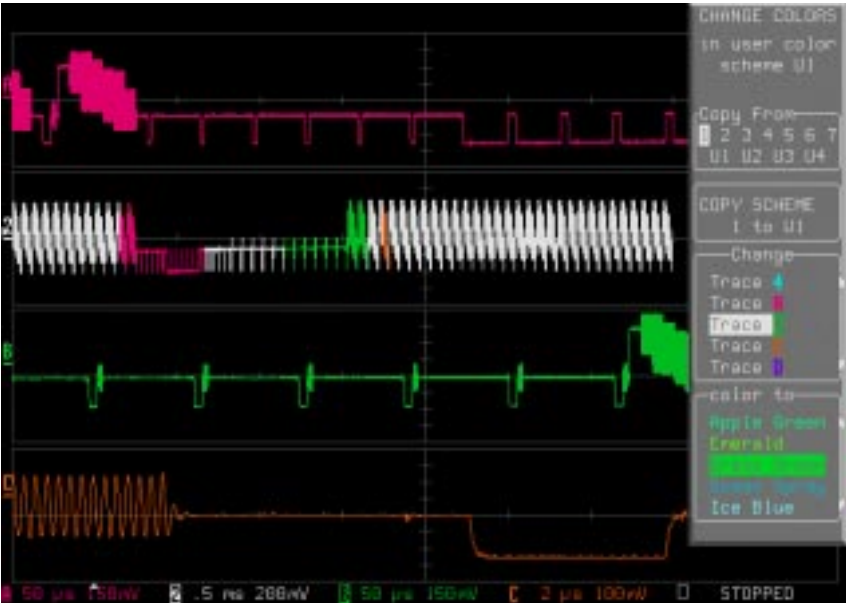

And in the final screen on the next page, "Text & Menu" has been selected and colored "Yellow".



Measuring Skills

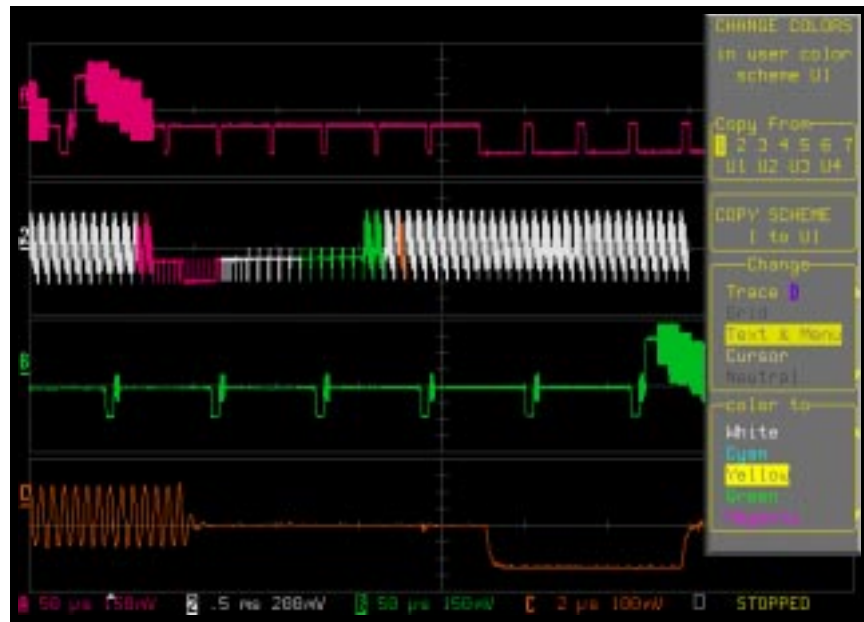

Cutting Deadtime Between Events

Sequence mode goes beyond single-shot acquisition, offering a choice of fixed-size, complete-waveform segments without unwanted deadtime (see *Appendix A* in the *Operator's Manual* for the limits).

The long intervals of deadtime that often separate consecutive single-shot events are minimized in sequence mode. Complicated event sequences covering large time intervals are captured in fine detail — without the uninteresting periods between.

Application Setup

Connect the signal — a pulse train (each group of 12 pulses separated by a long signal that need not be acquired) — to CH 2.

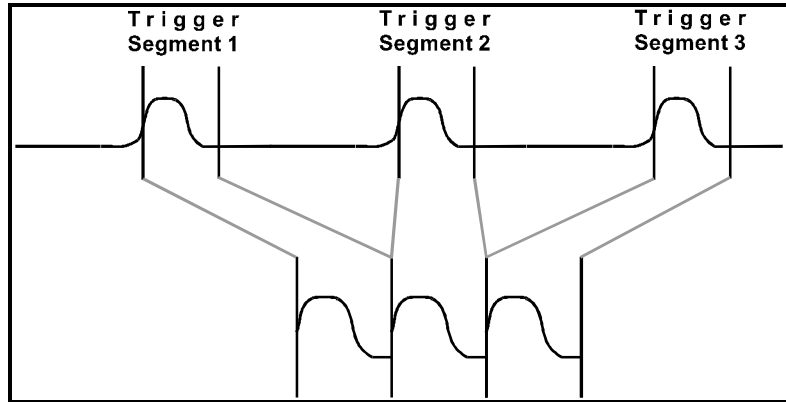

Measuring Skills



This schema represents how Sequence Mode handles sequence acquisition. The display is activated pressing SHOW STATUS and selecting "Text & Times" from the menu that appears.



Segment	Time	since Segment 1	between Segments
1)	17-Feb-1995 09:16:01		
2)	17-Feb-1995 09:16:01	5.999983 ms	
3)	17-Feb-1995 09:16:01	11.999965 ms	5.999983 ms

STEP 1 

Reset: press , the top  and  simultaneously.

Then press  to turn off Trace 1, and display:

STEP 2 

Press , then the corresponding  to select from the "Coupling" menu the coupling matching the source's impedance — 50 Ω.

STEP 3 

Press  again.

STEP 4 

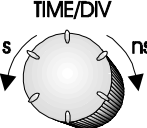
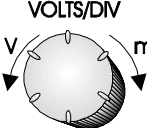
Turn  to adjust the timebase, and  to adjust the gain and fill the screen with the signal.

Cutting Deadtime

The screen will display:

Note: This screen shows only one of 12 train pulses.

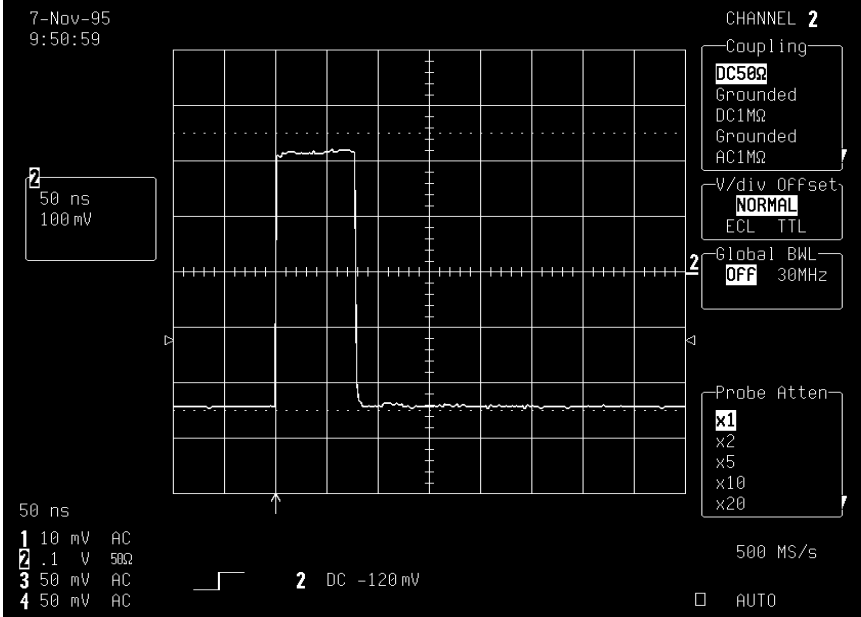

STEP 5 

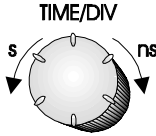

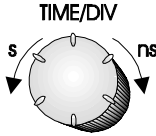
Again turn  to adjust the timebase, this time to display all of the train's pulses.

STEP 6 



Now press





Measuring Skills

The screen will now display:

Note: The "TIMEBASE" information shown at top-right-of-screen, consists of, in this example:

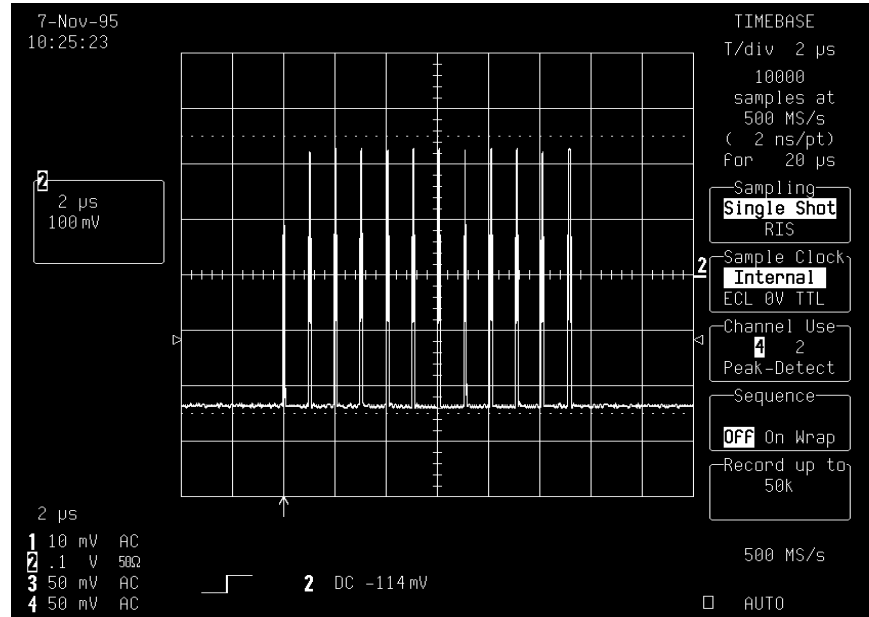
*Timebase value — 2 Os/div;
Number of samples acquired — 10 000;
Sampling rate — 500 MS/s;
Time between samples — 2 ns/point;
Total time acquisition — 20 Os.*



STEP 7 

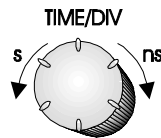

Again turn  to adjust the timebase, this time until two pulse trains are acquired.

Cutting Deadtime

The screen will then display:

Note: As shown at top-right-of-screen, the sampling rate has decreased as the total window time acquisition has increased. Between two trains, a long ground-level signal of no interest has been acquired.

Sequence Mode, activated at the next step, is the best way of acquiring the zone of interest only.

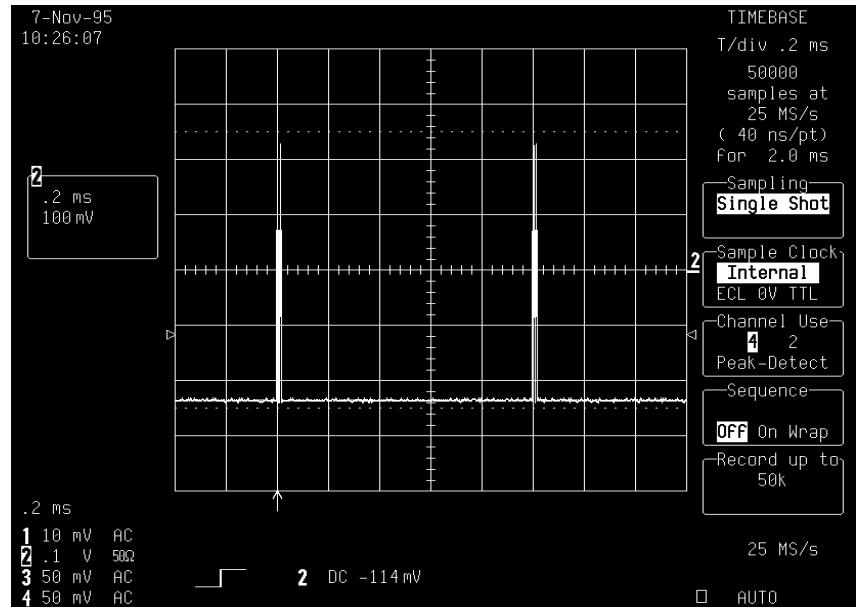

STEP 8 

Press 

Then press the corresponding menu  to select “On” from the “Sequence” menu.

Next, turn the lower ‘menu’  to display “2 segments” in the “Sequence” menu.

Press 



Measuring Skills

Now in Sequence Mode proper, the screen displays:

*Note: The number of trains acquired is now four, with the same sampling rate as for two. The sole difference is that now the duration between two train pulses is half what it was. In the trace label, at left-of-screen, the symbol "2x" indicates two segments acquired in Sequence Mode. The TIMEBASE information shows that two segments of 50 000 points each ("2 * 50 000") have been acquired.*

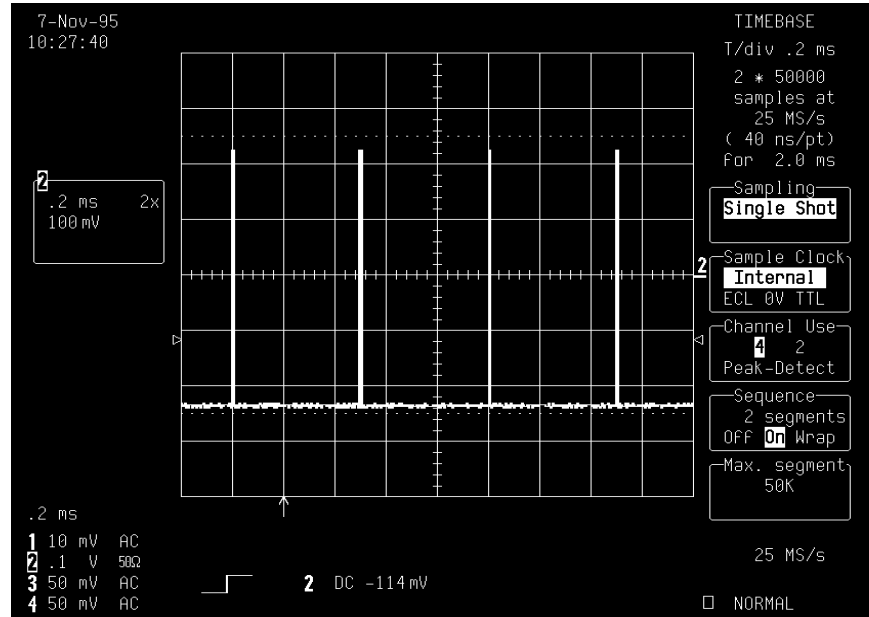

Tips: The bottom menu shows the maximum number of points per segment — in this instance, 50 000. The sampling rate or the total number of acquired points can be adjusted.

The timebase setting in Sequence Mode is used for determining the acquisition duration of each segment — 10 x TIME/DIV. This setting, as well as the number of segments desired, the maximum segment length, and the total memory available, are used for arriving at the actual number of samples per segment, and the time per point.

Cutting Deadtime

Here, the Sequence Mode timebase of 2 Os/div has been selected (corresponding to a single train duration, as already covered at Step 5). The sampling rate is the maximum, and the two trains are captured with a very short delay between triggers. The acquisition is in fact two acquisitions, each a train of pulses.

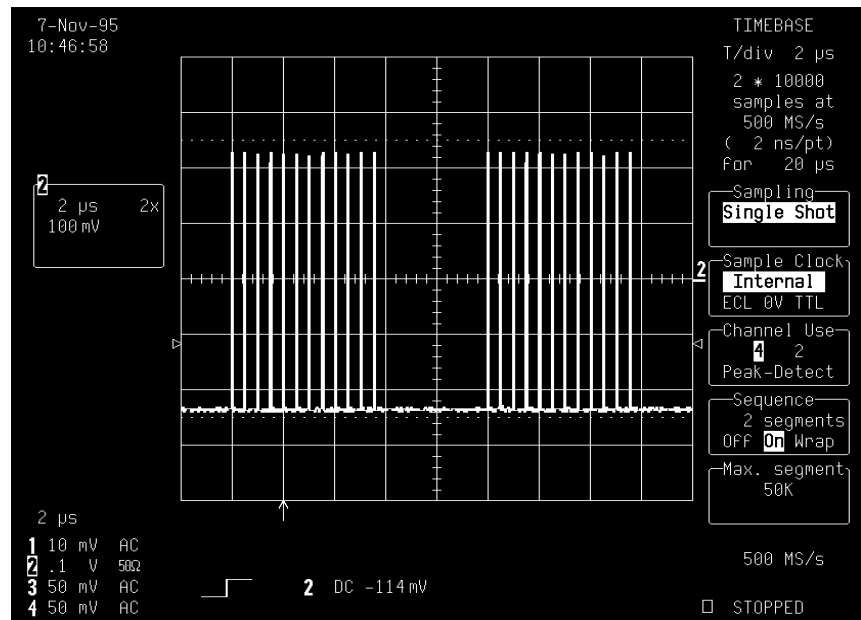

STEP 9

Turn the lower 'menu'  to set the number of segments.

On the example screen overleaf, the number of segments is set at eight.



Measuring Skills

Note: The complete waveform with all its segments may not fill the screen entirely.

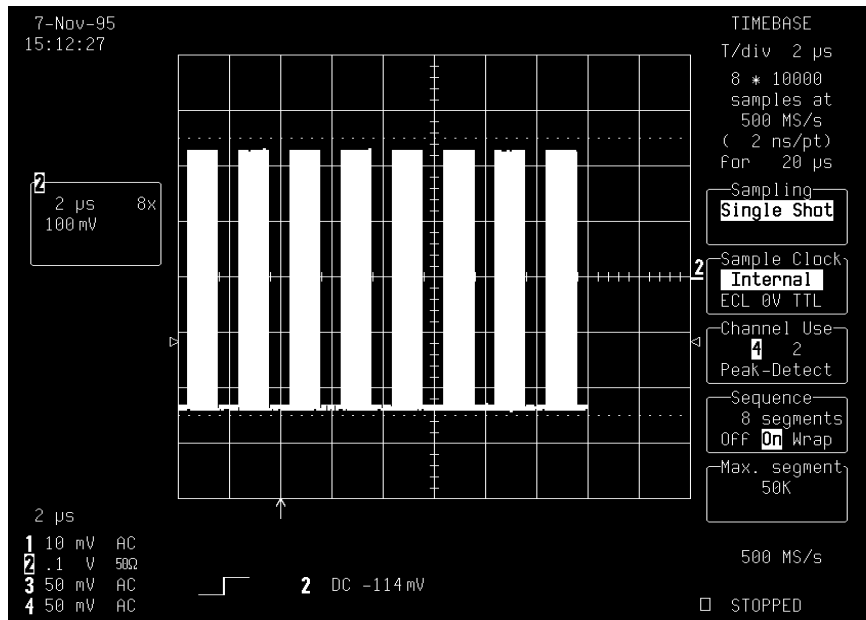

STEP 10 

SHOW
STATUS
Press 

Then (twice) press the corresponding menu  to select "Text & Times" from the "STATUS" menu.

Cutting Deadtime

Finally, the screen will display:

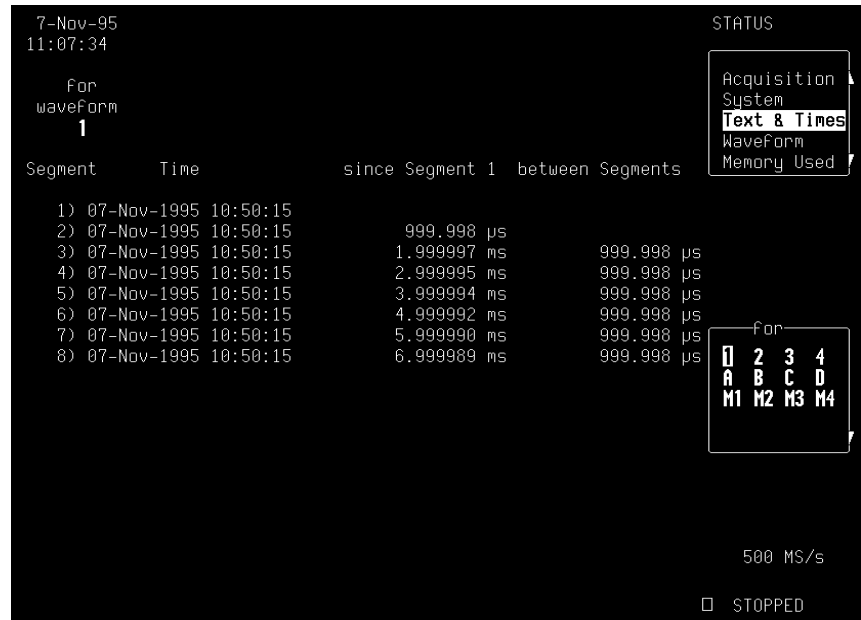

Time measurements are made between events on different segments of a sequence waveform using the full precision of the acquisition timebase. Trigger time stamps are given for each segment.

Tips: Each segment can be displayed using ZOOM, or used as input to the MATH package.

For remote operation, Sequence Mode can be activated to take full advantage of the scope's large data-transmission capability.



Measuring Skills

Sequence mode is normally used for acquiring the desired number of segments and for terminating the waveform acquisition. However, it can also be used with the WRAP option to acquire the segments continuously, overwriting older segments as required. A manual STOP order or time-out condition can then be used to terminate the acquisition.

*The operation of the STOP, SINGLE, NORMAL, and AUTO buttons is modified when Sequence Mode is used (see Chapter 7 of the **Operator's Manual**).*

To ensure low deadtime between segments, button-pushing and knob-turning should be avoided during sequence acquisition.







The Scope as Spectrum Analyzer

The FFT (Fast Fourier Transform) package transforms your oscilloscope into a spectrum analyzer for frequency domain analysis. Showing the signal in the frequency domain, it eliminates the need for another, separate instrument. Explained here is how to measure signal power distribution as a function of frequency.



Application Setup

Connect the signal to be measured — a CAL BNC signal at a frequency of 1 kHz — to CH 1.

STEP 1 

Reset: press , the top  and  simultaneously.
Then press  to turn off Trace 2.

STEP 2 

Press , then the corresponding  to select from the “Coupling” menu the coupling matching the source’s impedance — 50 Ω .

STEP 3 

Press  again.



Measuring Skills

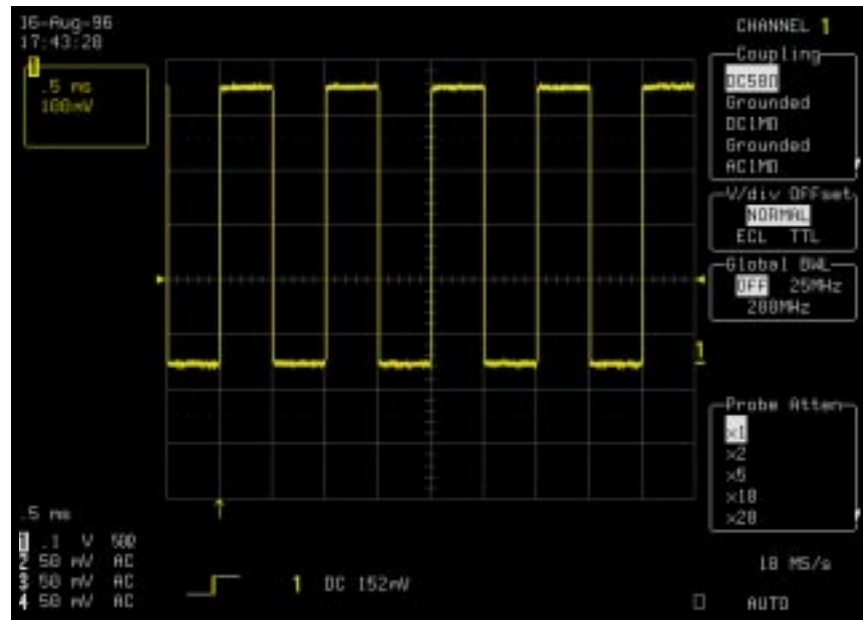

STEP 4 

Press 

STEP 5 

Press the corresponding menu  to select “Dual” from the “Grids” menu.

Spectrum Analysis

The screen will then display:

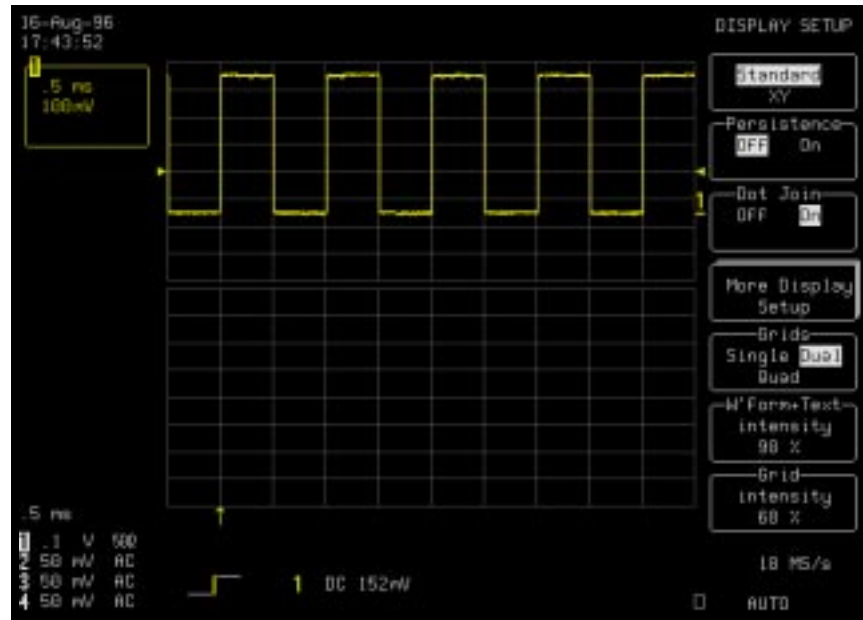

STEP 6 

Press **MATH SETUP**

STEP 7 

Press the corresponding  to select "REDEFINE A".

STEP 8 

Next, press the  to select "Yes" from the "use Math?" menu.



STEP 9 

Then press the  to select “FFT” from the “Math Type” menu.

STEP 10 

Now press  to turn on TRACE A.

The screen will now display:

Note: Several different types of FFT results, windows and sources can be selected from the “FFT result” menu, shown here. See Appendix C of the Operator’s Manual for details. On this screen, “**Power Spectrum**” has been selected for characterizing spectra containing isolated peaks.

FFT information listed in the box beneath the grid includes: Nyquist frequency — the input signal must have components of a frequency lower than that of the Nyquist in order to avoid aliasing; Δf — the distance in hertz between the center frequencies of two neighboring FFT bins, where $\Delta f = \frac{1}{\text{Time}/\text{Div} \times 10}$; 500 pts — the total number of FFT points.

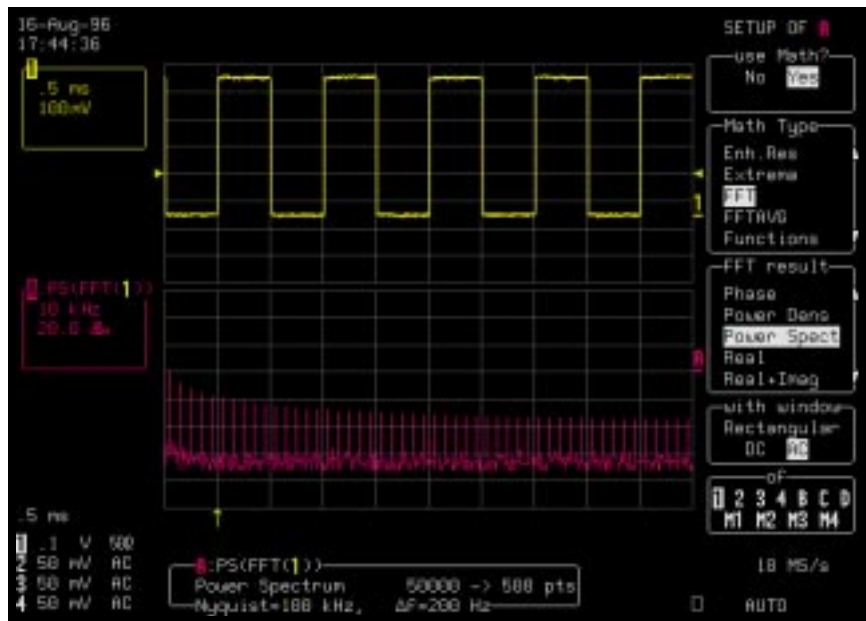

Tips: To enable any Math function to use more of the acquired data, press MATH SETUP and set “for Math use Math points” to the maximum value — 10 million. The scope will use all of the acquired data. Calculations will be slower but more accurate. In this example, the FFT is performed on all 500 points of acquired data.

Spectrum Analysis

STEP 11 

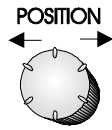

Turn  to move the trace to the right of the screen and zoom the lower frequencies.

The screen will then display:

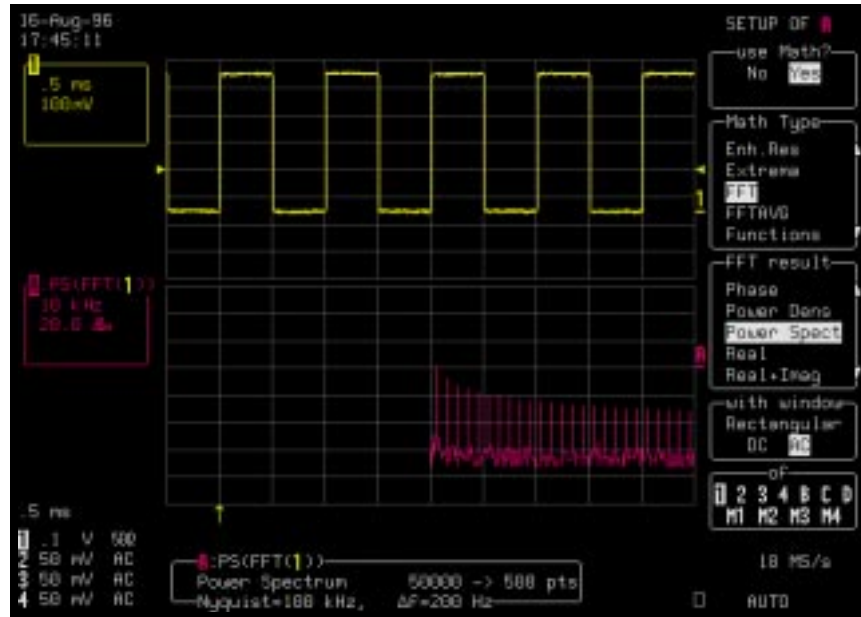

STEP 12 

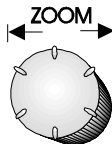

Turn  to obtain details of the lower frequencies.



Measuring Skills

The screen will then display:

Note: The scale in the "Trace A" trace label at left-of-screen changes when zooming. Here, the dual frequencies are 1 kHz and 3 kHz.

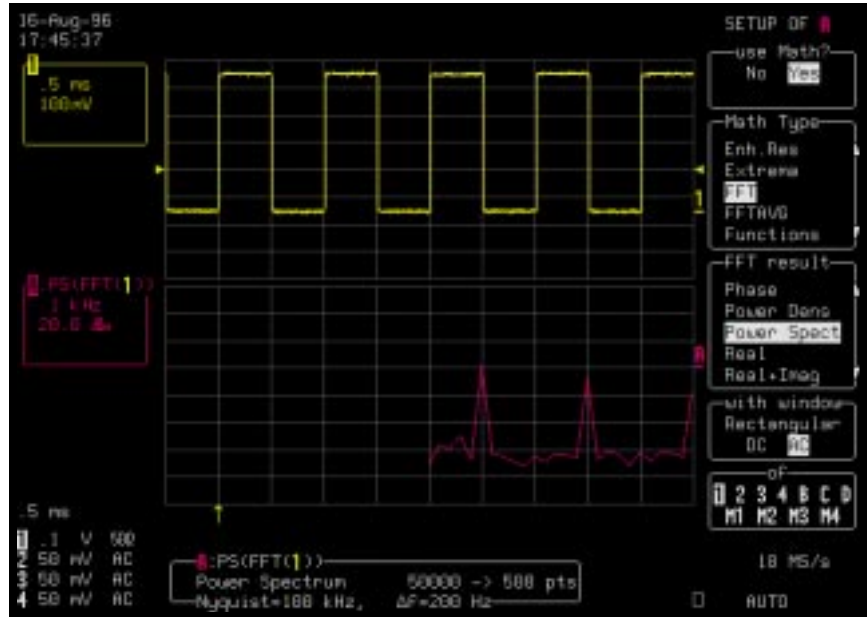

Tips: The frequency span can be made greater by increasing the number of points acquired. There are several ways of doing this, but basically acquired points are multiplied by increasing the value in the TIMEBASE "Record up to" menu, or by selecting a slower timebase while keeping the same sampling rate.

Spectrum Analysis

Note: Rather than zoom the FFT directly, it is possible to zoom on a copy of the FFT on Trace B (as is shown here), C or D.

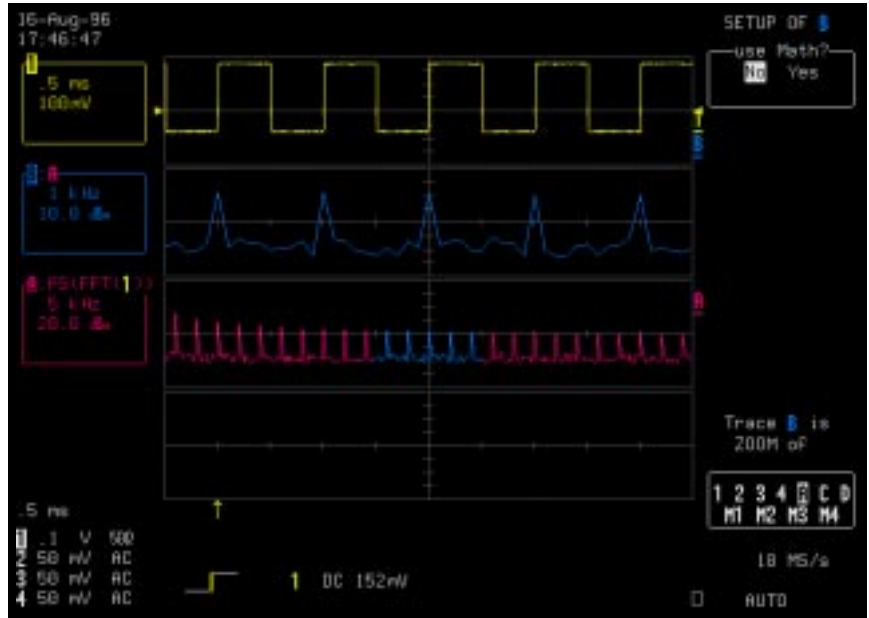

(From top) Squarewave signal, FFT and FFT zoom on Trace C.





Precision Analysis with Histograms

The WP03 Waveform Processing package — a powerful tool for the statistical analysis of waveform parameters — allows histograms to be made for any supported parameter, for quick and precise acquisition information. Here’s how to use this parameter-distribution-analysis firmware with histogram to display and calculate signal jitter distributed across acquisitions.

Software Required

WP03 parameter-distribution-analysis firmware with histogram for LeCroy oscilloscopes.

Application Setup

Connect the signal to be measured — which should show edge jitter — to CH 2.



STEP 1

Reset: press , the top  and  simultaneously.

Then press  to turn off Trace 1.

Analysis with Histograms

STEP 2 

Press  , then the corresponding  to select from the “Coupling” menu the coupling matching the source’s impedance — 50 Ω .

STEP 3 

Press  again.

STEP 4 

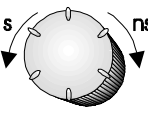
Turn  to select a single period of the signal.

The screen will display:

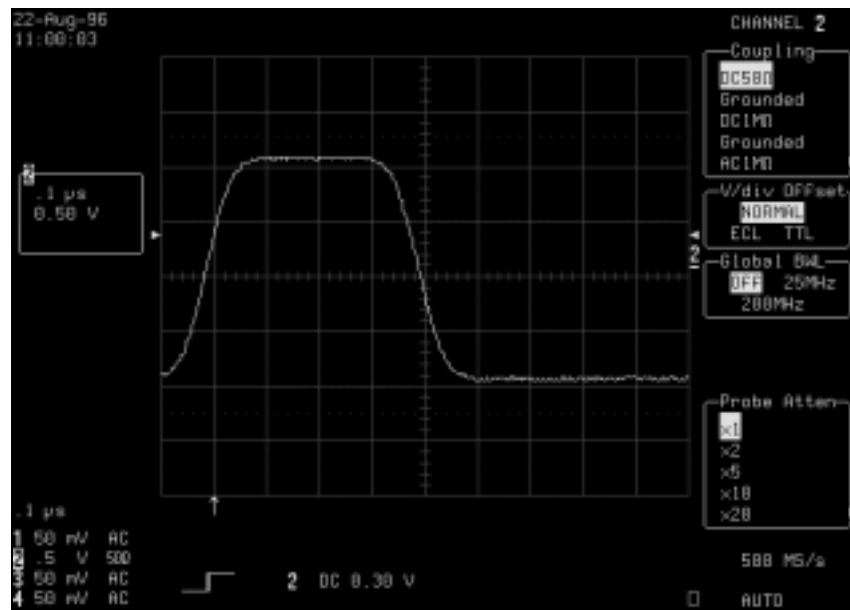



Measuring Skills

Tips: Persistence Mode can be used to show the width variation, or jitter, of the acquired signal. By pressing DISPLAY and then the menu button to select “On” from the “Persistence” menu, the signal can be displayed with edge jitter in persistence mode, as shown here. Persistence should then be turned off.

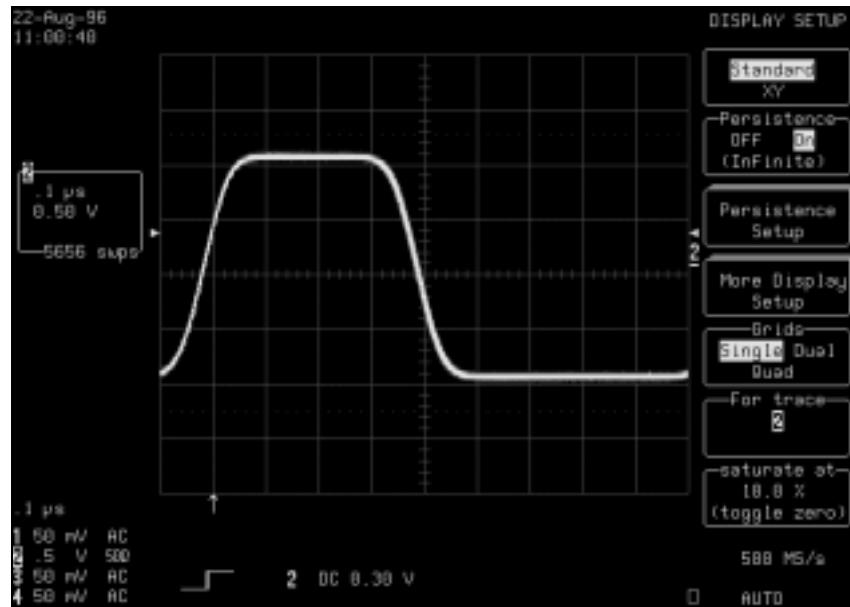

STEP 5 

MATH
SETUP

Press  to access the “ZOOM + MATH” menus.

And then press the corresponding s for “REDEFINE A”, and then to select “Yes” from the “use Math?” menu.

Analysis with Histograms

The screen will now display:

Note: The Average function in the "Math Type" menu is selected by default. All functions that can be set up with standard and optional software where installed are shown in this menu.

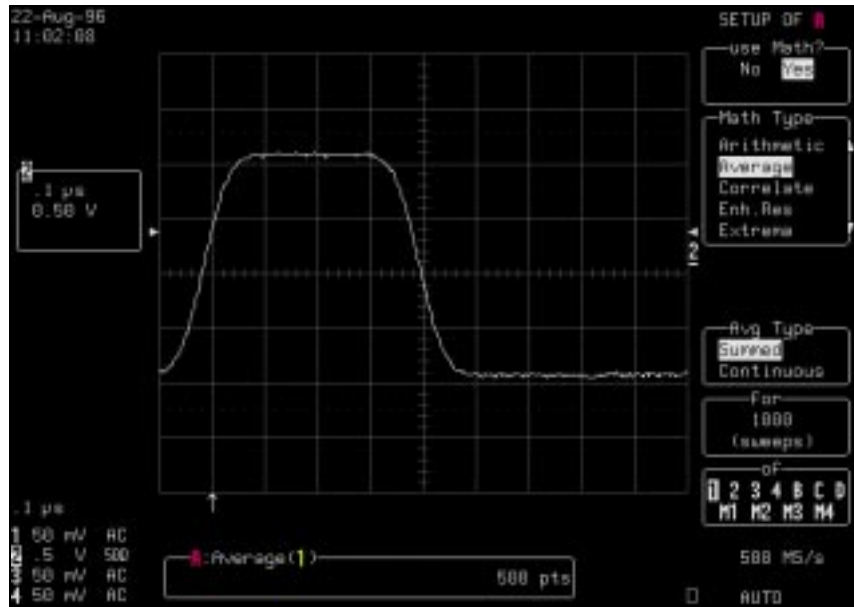

STEP 6 

Press the corresponding  to select "Histogram" from the "Math Type" menu.



Measuring Skills

The screen will display:

Note: The Histogram function records the selected parameter values and presents data in a statistical form. It produces a waveform consisting of one point for each histogram bin, where the value of each point is equal to the number of parameter values falling into the corresponding bin. Analysis of histogram distributions is supported by a wide range of automated statistical parameters, and provides insight into, and quantitative analysis of, difficult-to-measure phenomena.

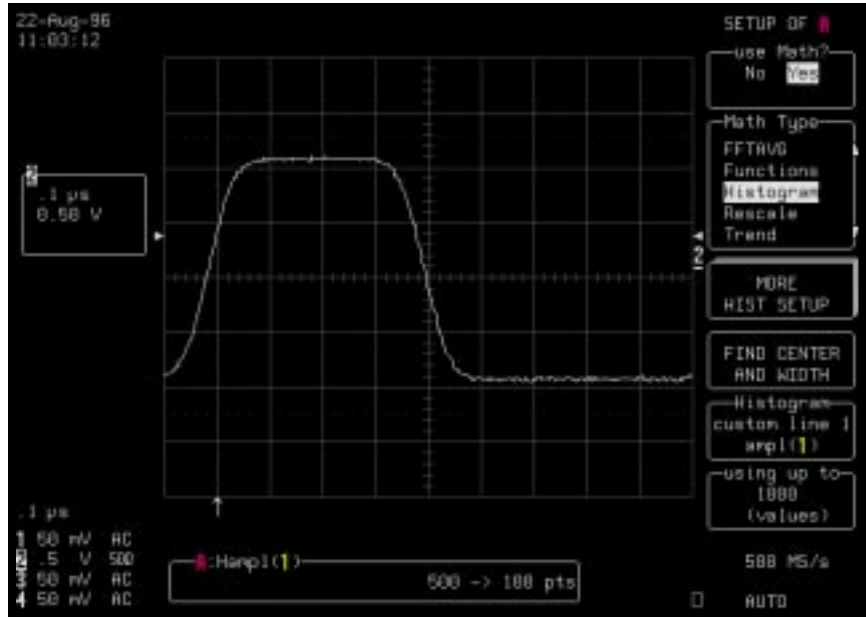



STEP 7

Press the corresponding menu  for “MORE HIST SETUP”.

Analysis with Histograms

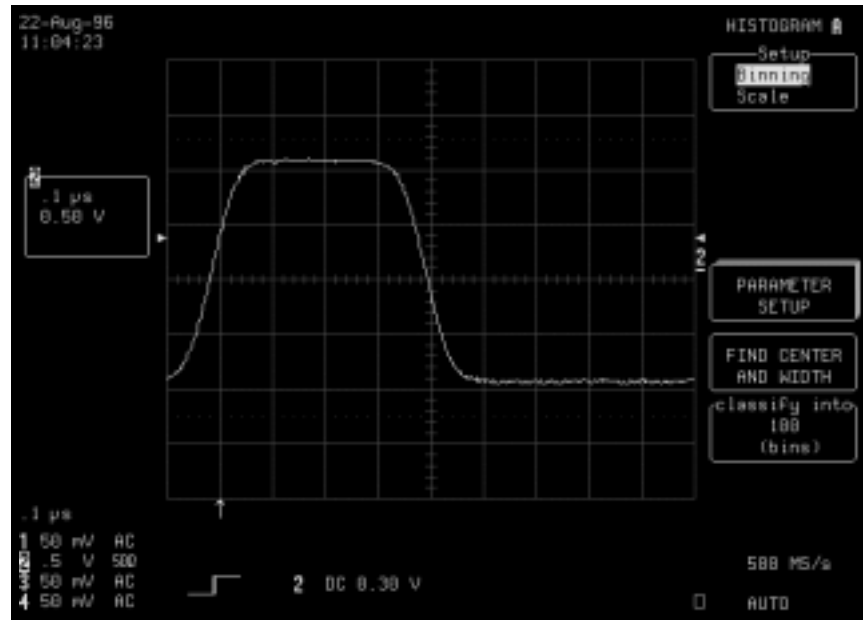
The screen will now display:



STEP 8 

Press the corresponding menu  for "PARAMETER SETUP".



The screen will display:

Note: The software installed in the oscilloscope determines which sets of parameter categories are available from the "Category" menu. Categorizing the parameters simplifies their selection. For example, those parameters useful for characterizing histograms are grouped under "Statistics" (further down the menu and not visible here). And, and as the name suggests, the "All" category covers all parameters.

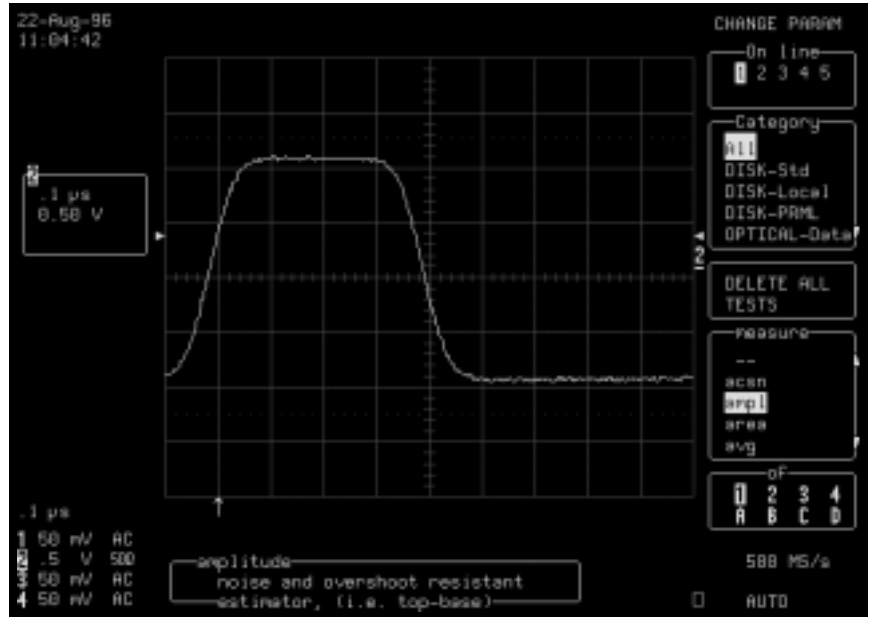

STEP 9

Press the corresponding or turn the upper to select from the "measure" menu the parameter for which the histogram is to be made — "width" in the example screen that follows.

Then press or turn the lower to select the channel on which the measurement will be performed — "2" in this case.

Analysis with Histograms

Note: A short definition of each parameter selected is displayed under the grid. (See the Operator's Manual for more details.)

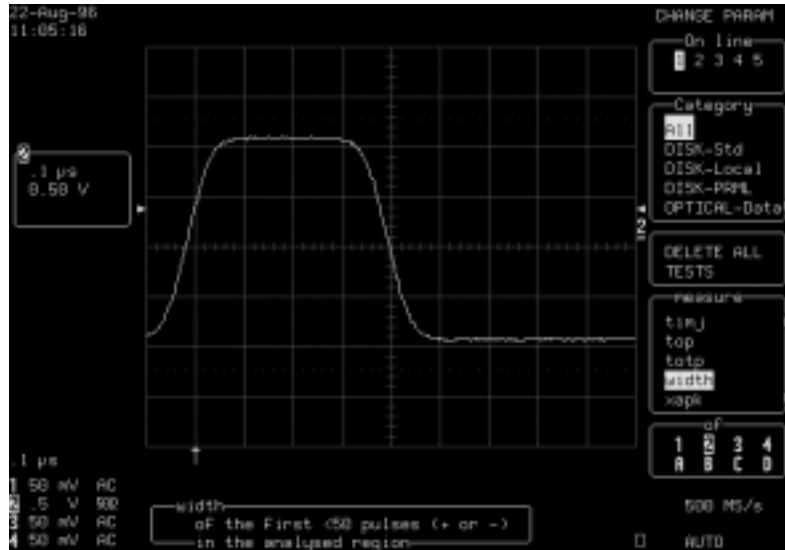

Tips: Press the menu button for “DELETE ALL TESTS” if preliminary parameters have been set up in a previous acquisition, to ensure the newly chosen parameters form the required set.

STEP 10 

Press  to turn off CH 2, then  so that only Trace A, the histogram of the width of the trace acquired on CH 2, is displayed.



Measuring Skills

The screen will display:

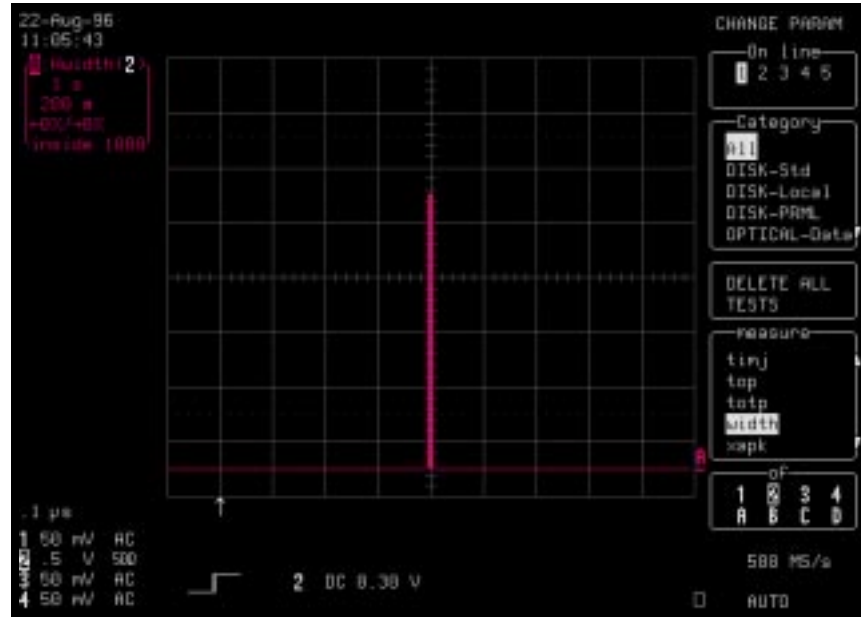

STEP 11

Press  to go back to the preceding menu, allowing the histogram to be set up.

Then press the  for "FIND CENTER AND WIDTH".

As shown on the next screen, the horizontal axis is set to a new scale, accurately showing the distribution.

Analysis with Histograms

Note: The trace label shows the horizontal scale — here, 5 ns/div, which corresponds to the width values. It also displays the vertical scale — #10/bin, corresponding to the number of acquisitions for the same width value. As well, it shows the percentage of width values off-screen left and right; in this example, all width values are within screen limits. And, finally, it displays the number of acquired and measured parameter values used to create the histogram.

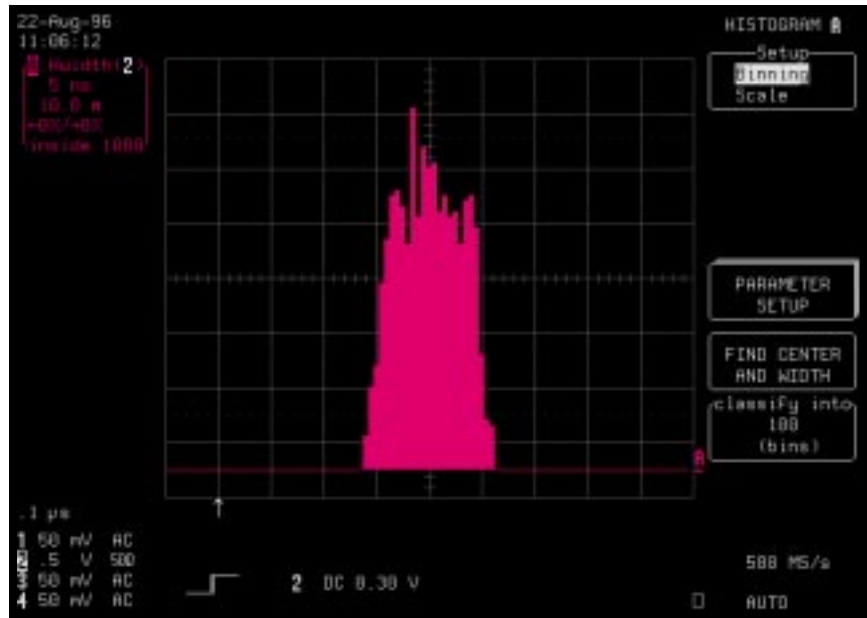

All values displayed in the trace label can be changed as required. Because Trace A is a function, horizontal and vertical scales and positions — and thus zoom — can be used for the histogram. Pressing the RESET button cancels all changes and displays the original histogram.



Measuring Skills

This screen shows a histogram whose horizontal and vertical display parameters have been adjusted.

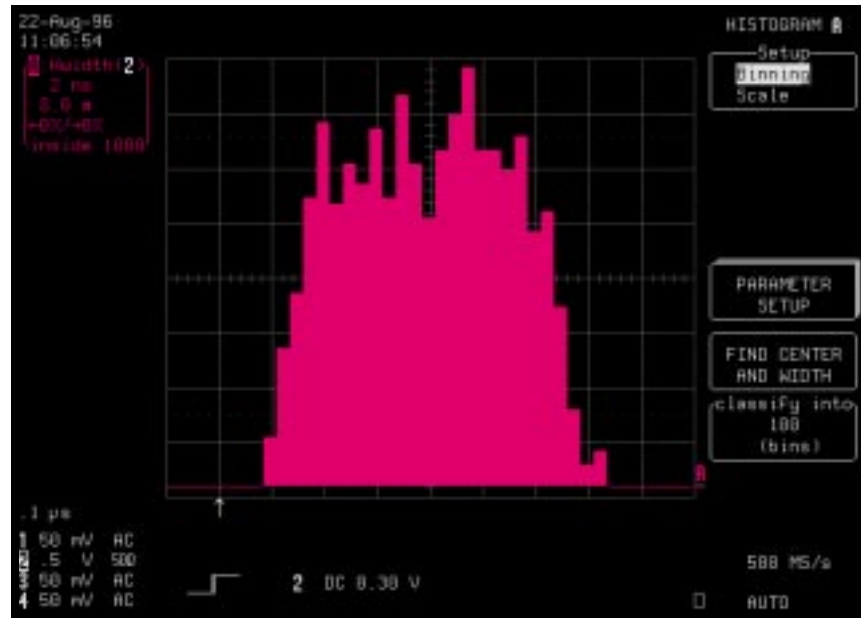

Turning the upper 'menu' knob will change the number of bins that classify the different parameter values. When this number is changed, the new horizontal scale is adjusted and displayed in the trace label, as shown on the facing page.

Analysis with Histograms

This screen shows the histogram after bin-number adjustment:

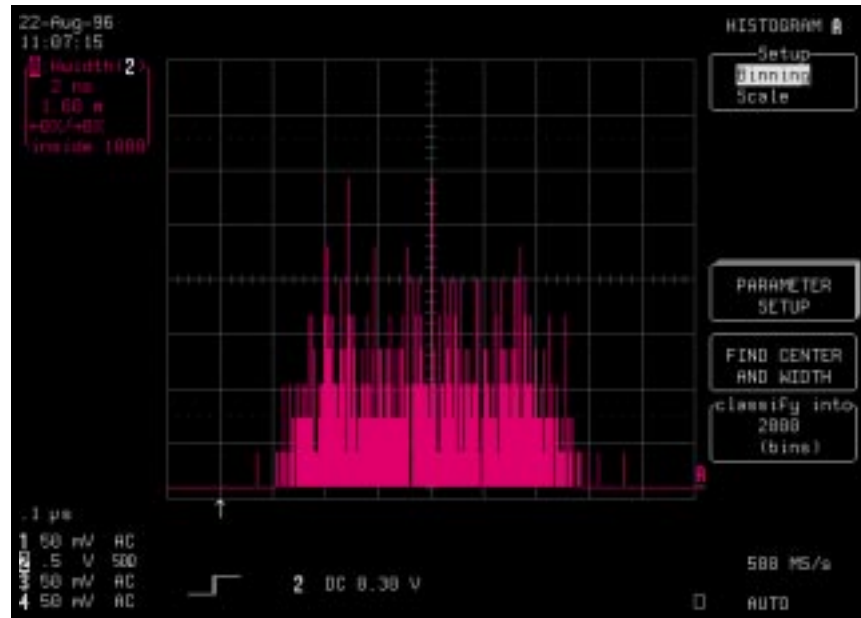

Tips: As many as two billion measurements can be included in a parameter histogram display. This limit is set by pressing the RETURN button in order to go back to the "SETUP OF A" menus. The appropriate menu button or knob is then used to set the required limit in the "using up to" menu (see screen following Step 6).



Measuring Skills

The final steps in this tutorial describe how to select parameters that characterize the histogram. Many statistical measurements can be made on the histogram for analysis of the characteristics of selected parameters — including the highest value, standard deviation, and the most common value of the histogram.

STEP 12 

CURSORS/
MEASURE

Press 

Then press the s to select “**Parameters**” from the top menu, and “**Custom**” from the “mode” menu, thus enabling Custom Parameter mode.

The screen will display:

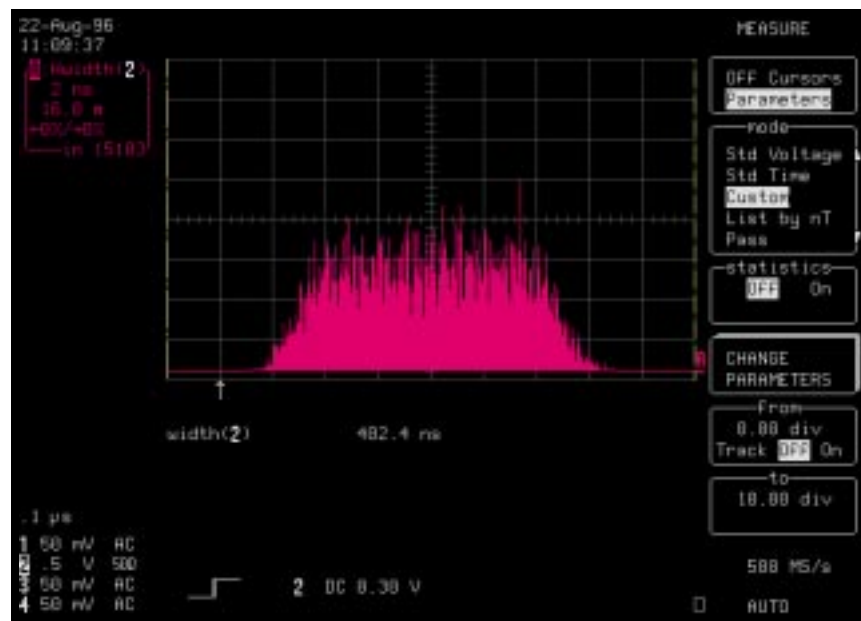

Analysis with Histograms

STEP 13

Press the corresponding  for “CHANGE PARAMETERS.”

The screen will display:

Note: The Custom Parameter mode allows up to five parameters to be selected. The width parameter, set earlier in the “Histogram” menu (Step 6), must be retained on line “1” in the “On line” menu, as it has been used in the calculation of the histogram. However, the four other parameters may be added.

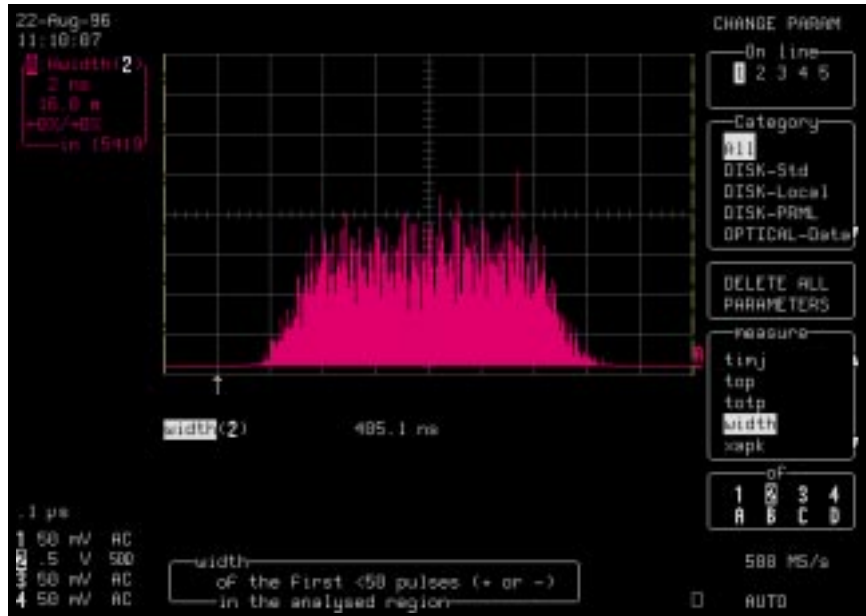

STEP 14

Press  to select a line other than “1” from the “On line” menu (to change this would lose the histogram data!).

Next, the  to select “Statistics” from the “Category” menu.

Then  to select Histogram “A” from the “of” menu.



Measuring Skills

The screen will display:

Note: Step 14 may be repeated, adding four additional parameters for characterizing the histogram. A description of each of these parameters is given on-screen under the grid in accordance with the parameter selected.

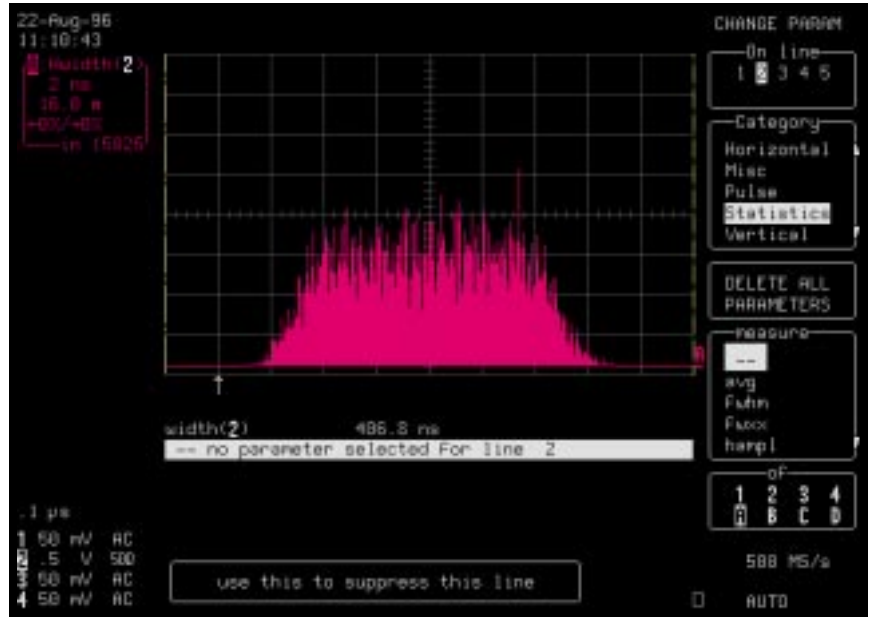

The final screens in this tutorial, which follow, show four different parameters characterizing the histogram of the width.

Analysis with Histograms

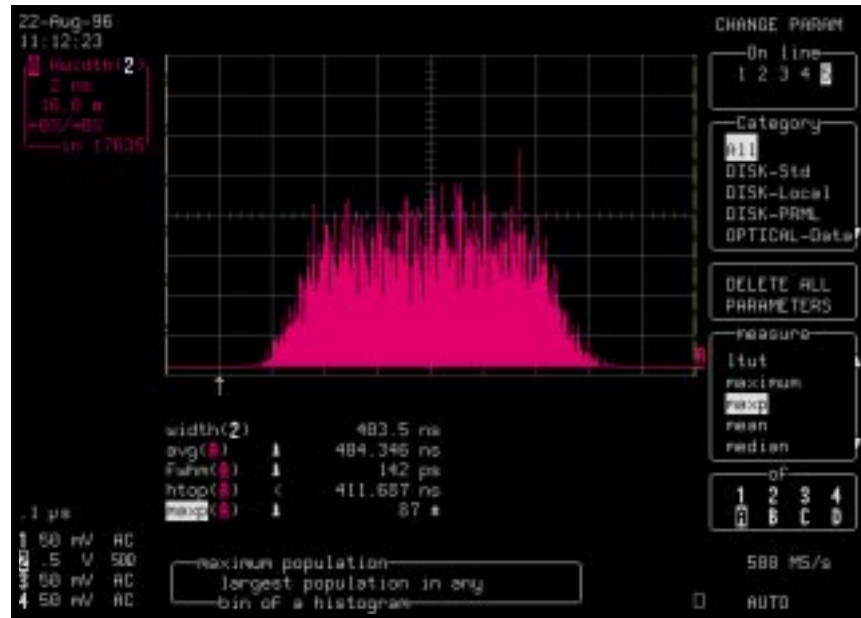

Tips: All the parameter values can be read on PC with the optional remote control using the PAVA? query.

Statistics “On” can be performed for all parameters. As shown on the final screen, four different values are displayed for each parameter. These are: average, lowest, highest, and sigma — the last being the standard deviation of the data values from the mean values.

Parameters can be applied to a chosen section of the histogram using the parameter cursors in the measure menu (see Characterizing a Pulse).



Measuring Skills

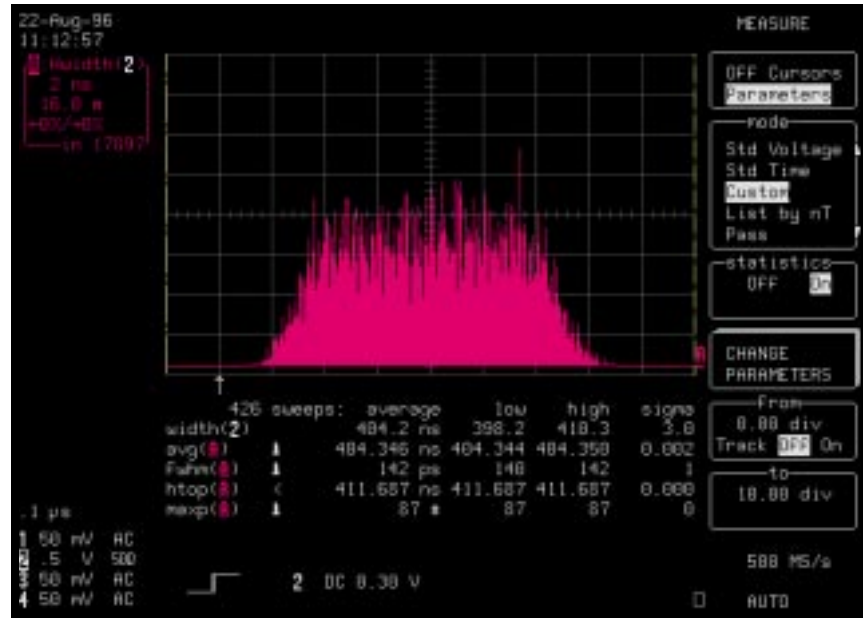

Interpolation = More Information

The $\text{Sin}(x)/x$ interpolation — a standard feature of LeCroy oscilloscopes — powerfully processes data acquisitions of a few sample points. It places nine interpolated sample points between each original data sample. This preserves the identity of the original raw data, allowing differentiation of raw from interpolated data points.

Because it must respect the Nyquist limit to avoid aliasing, it can be used only on signals having frequency components of less than half the sampling rate — here, a simple sine wave.

Application Setup

Signal to acquire on CH 2: 100 MHz sine wave.

STEP 1 

Reset: press , the top  and  simultaneously.

Then press  to turn off Trace 1.

STEP 2 

Press **COUPLING**, then the corresponding  to select from the “Coupling” menu the coupling matching the source’s impedance — 50 Ω .

STEP 3 

Press **AUTO SETUP** again.

The screen will display:

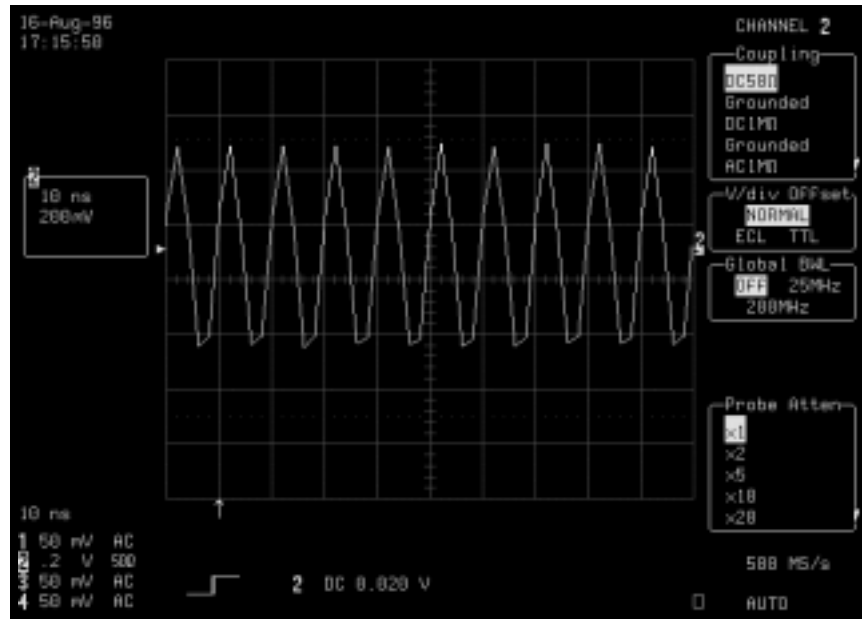

Tips: The 100 MHz sinewave is sampled at a rate of 500 MS/s. Thus each signal period has just five points — at the limit of obtaining a good representation of the signal.

Interpolation

STEP 4 

Now, press 

Tips: With the “DISPLAY SETUP” menus, one can show only the dots representing those points acquired. This is done by pressing the menu button to select **Off** from the “Dot Join” menu, as shown here.

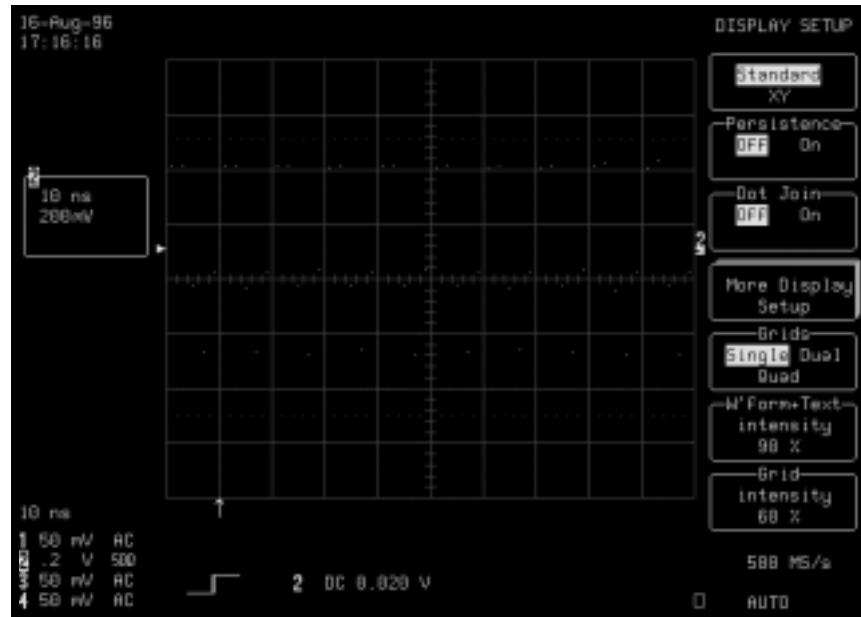

The number of points acquired, the time between the points, and the sampling rate of the acquisition are displayed when the TIMEBASE SETUP button is pressed. In this example, only 50 points are acquired, with 2 ns between each.



Measuring Skills

*Points can be made larger and more visible — bolder — by pressing “More Display Setup” and selecting **Bold** from the “Data Points” menu.*

The result is seen here:

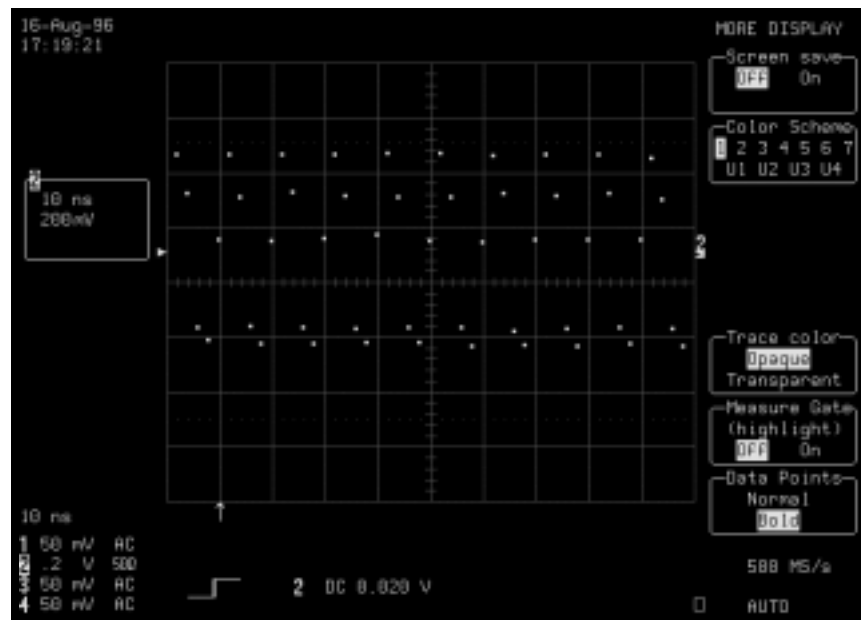

Interpolation

STEP 5 

MATH
SETUP
Press 

Then press  to select “REDEFINE A”.

The screen will display:

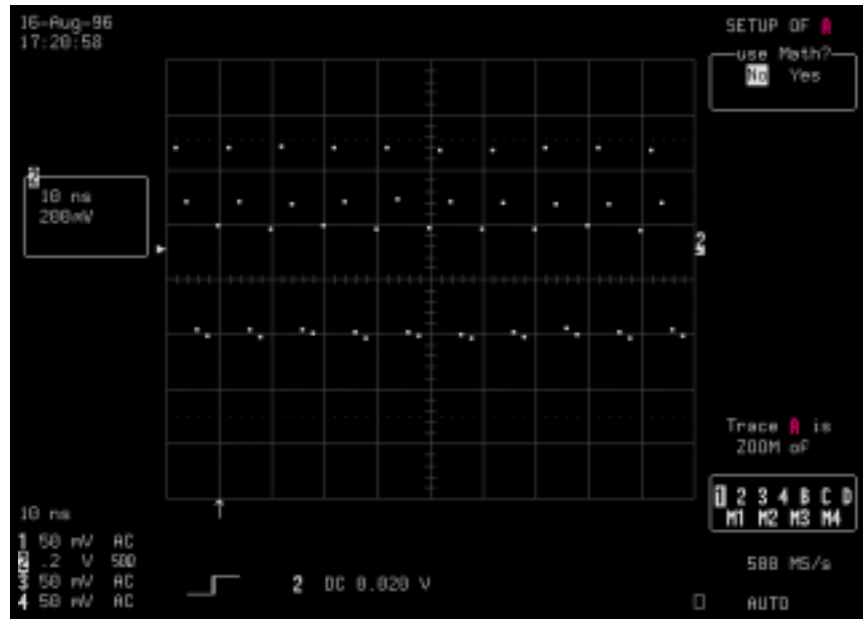

STEP 6 

Press the respective s to select “Yes” in the “use Math?” menu, and “**Functions**” from the “Math Type” menu, which will appear (*see page 3–95 for menu details*).

STEP 7 

Then press the s to select “SinX” in the “Function” menu, and “2” from the “of” menu.



The screen will now display:

Note: With the $\text{Sin}(x)/x$ interpolation selected, a label appears under the grid giving information on the function. Here, the interpolation will generate 500 points from the 50 of the original trace. The sampling rate is 500 MS/s and the Nyquist Frequency limit 250 MHz. The 100 MHz sinewave signal contains components whose frequency is lower than the Nyquist. The interpolation $\text{Sin}(x)/x$ can be performed without aliasing.

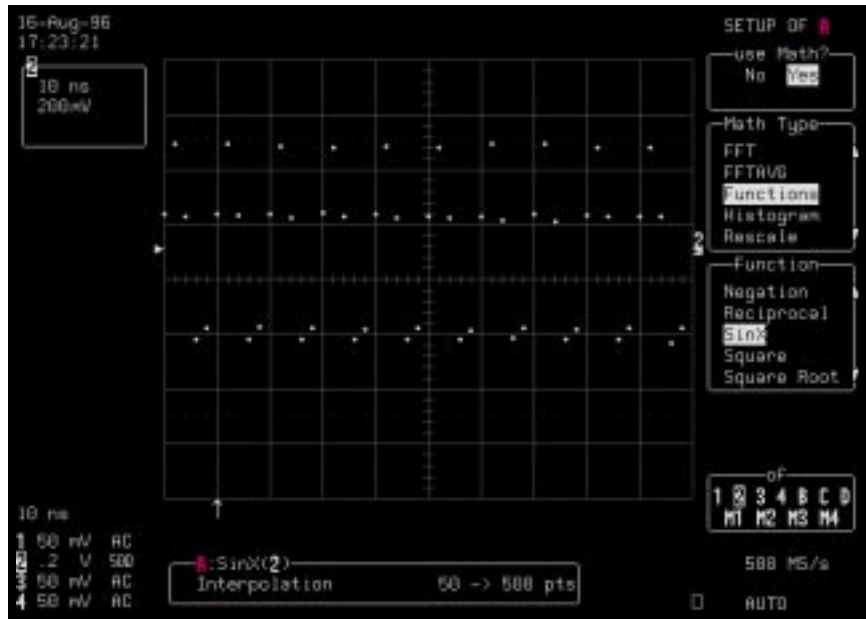

STEP 8

Press

Then press the to select "Dual" from the "Grids" menu (*next screen*).

Tips: Two traces can be displayed in each grid in Dual Display Mode. The first or upper grid's traces are described in the two upper (first and second) trace labels, whilst the two traces corresponding to the lower (third and fourth) trace labels are displayed in the second grid.

Interpolation

On the previous screen, CH 2 is in the second position. The next trace selected for display will be in the first position and both traces in the upper grid. To display CH 2 and Trace A each on a different grid, CH 2's trace label must be placed in the first position — done by pressing the CH 2 TRACE ON/OFF button off and on successively. TRACE A will then be placed automatically in the third position and thus displayed in the second grid.

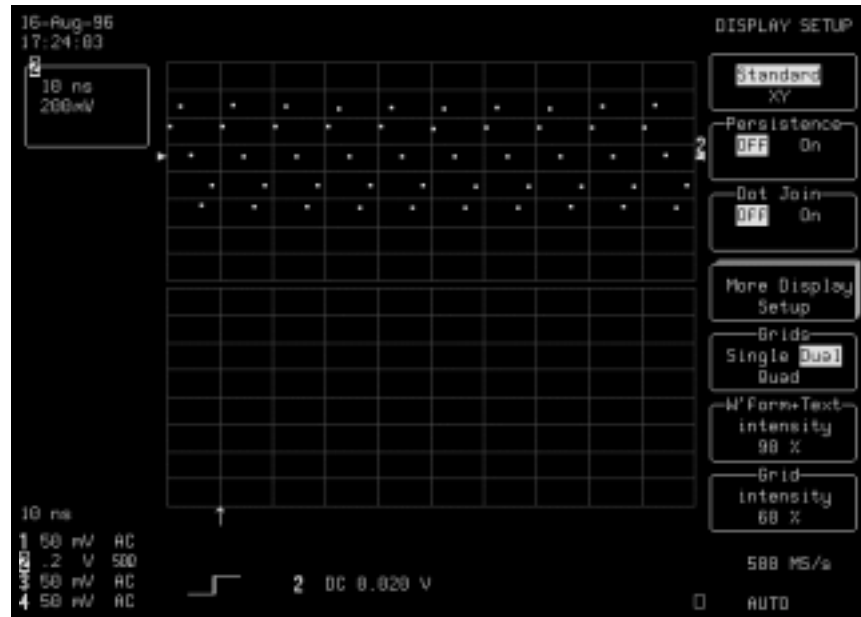

STEP 9 

Press  to display the interpolation of CH 2.



Measuring Skills

The screen will display:

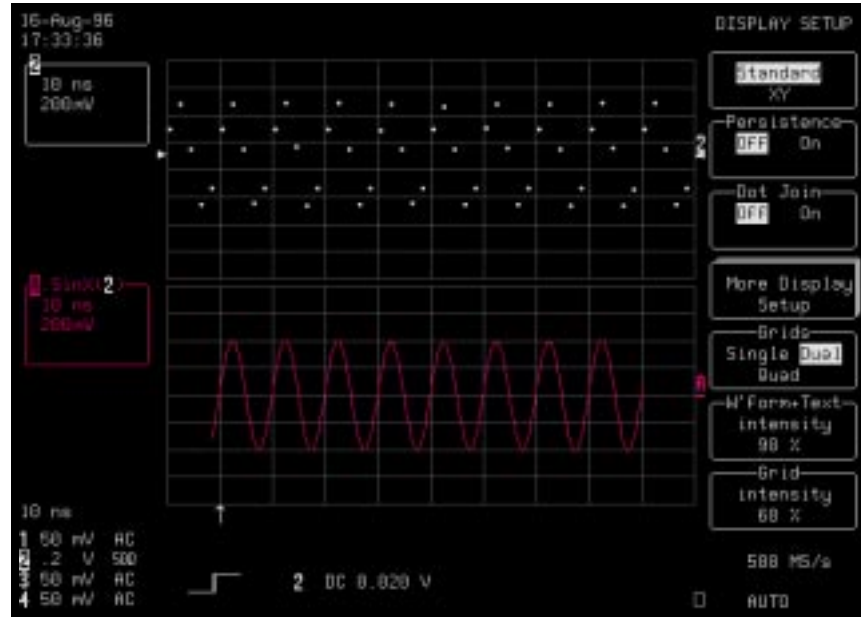

Tips: The $\text{Sin}(x)/x$ function is limited to 5000-point traces — a limit justified by the fact that an interpolation is designed to be performed on traces of only a few points. In addition, this limit avoids increasing the time taken for the calculation.

The exception, which needs to be approached a little differently, is acquisitions performed with a slow timebase. An example of this would be an acquired sinewave having 10 000 points but only four points per period. In such a case it is impossible to increase the number of points. However, the problem is solved by selecting a zoom of less than 5000 points on which to perform the $\text{Sin}(x)/x$ interpolation.

Interpolation

Note: Details of Trace A can be displayed using the vertical and the horizontal position and zoom knobs. In the final screen shown here, the timebase of A has been changed to show a detailed period of the signal on CH 2. There are 50 points per period on the interpolation of A, giving a better representation of the acquired sinewave when compared with the original CH 2 signal.

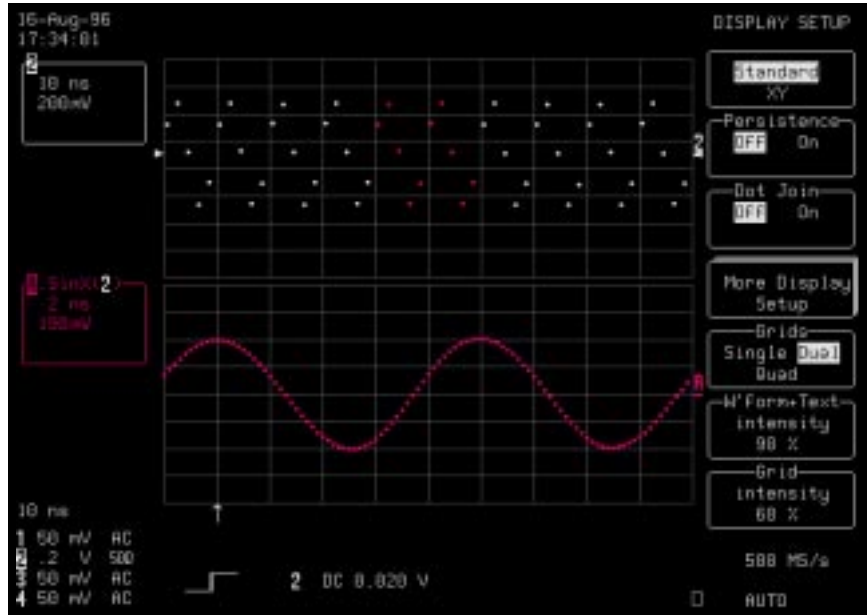



Testing Against a Telecom Mask

The scope's capacity to test waveforms against a defined mask enables telecom measuring of pulse-shaped signals to CCITT, ANSI and ISDN standards, without mylar overlays. Mask measurements, time-consuming with analog machines, are automatic with LeCroy's software. The computed Pass/Fail function offers greater accuracy with ease in repeating measurements.

Another plus: when a test fails, a TTL pulse output — just one example — can be used to drive a separate test device, eliminating the need for expensive production-testing software. Test masks are available on memory card or floppy. And the scope is transformed into a telecom physical-layer tester.

Telecom Mask Testing



Required

TC1 Telecom Masks option from LeCroy on floppy or memory card.

Application Setup



Connect the signal to be measured — and tested against the telecom mask — to CH 2.

STEP 1

Reset: press , the top  and  simultaneously.

Then press  to turn off Trace 1.

STEP 2

Press , then the corresponding  to select from the “Coupling” menu the coupling matching the source’s impedance — 50 Ω .

STEP 3

Press  again.

Having set up the scope, the next step is to call up the telecom mask to be used for the test. For this example, from the TC1 option we use the mask CCITT G703 Fig 22 (97 728 kb), stored on floppy. However, any of the other masks available on floppy or memory card can be used.

STEP 4

Insert the floppy in the scope’s drive and press .

Then press the  to select “Flpy” in the “from” menu.



Measuring Skills

The screen will display:

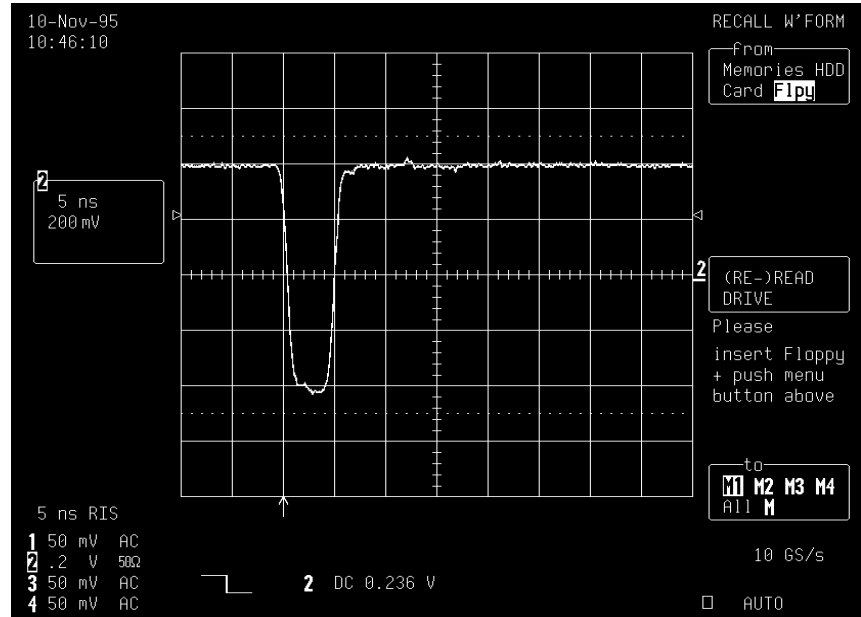

STEP 5

Press the corresponding menu  for “(RE-) READ DRIVE”.

Then turn the upper  to select the desired mask — **CCITT G703F22**.

Next, press the corresponding menu  for “DO RECALL”.

Telecom Mask Testing

The screen will then display:

Note: The message "G703F22 recalled from floppy" will be displayed at top-of-screen. The mask is now stored in the volatile internal memory M1, as indicated in the "to" menu.

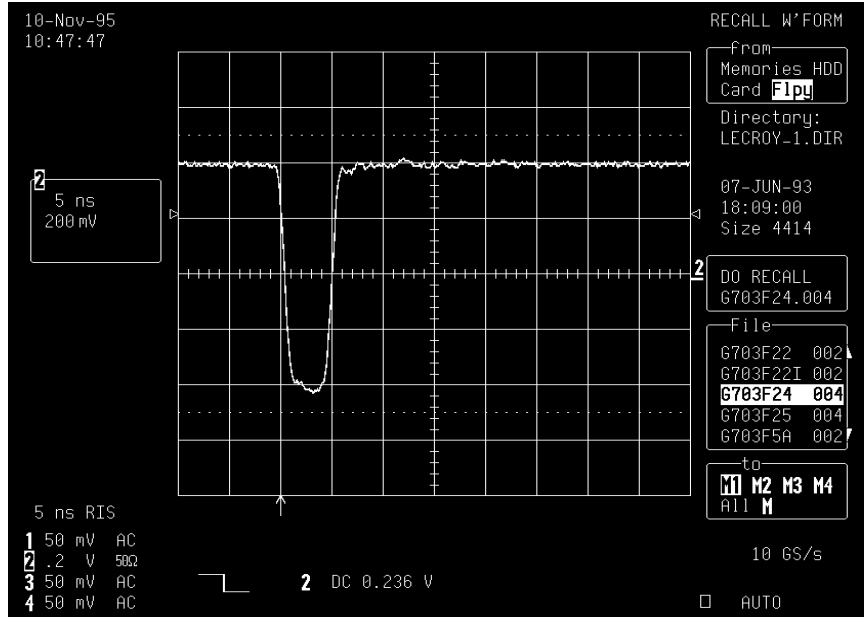

STEP 6 

Press  to display the recalled mask.



Measuring Skills

The screen will display:

Note: A maximum number of points can be selected in the “for Math use” menu by turning the lower menu knob in the SYSTEM SETUP group of controls. This can be for limiting the calculation or the amount of processing memory used or both. Here the function is performed simply to show the trace stored in M1 and can be considered as a zoom with a factor of one. The acquisition is a 500-point trace and the default value of “up to 1000 points” would be sufficient.

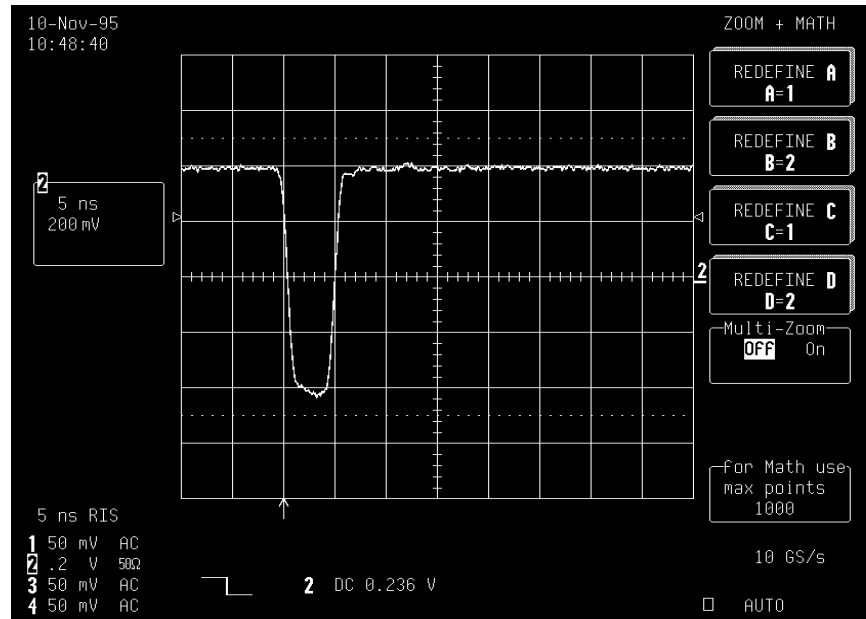

STEP 7

Press the corresponding menu s for “REDEFINE A” and then for “Trace A is ZOOM of” “M1”.

Then press  to turn on Trace A and display the mask.

Telecom Mask Testing

The screen will then display:

Note: The following important information on the mask is given in the trace label... Horizontal: timebase is 1 ns/div. — the test will be performed only if the trace to be tested against the mask has the same timebase as the mask; Vertical: gain is 20% per division — meaning that each vertical division is equal to 20% of the difference between the mean top value accepted by the mask and the mask's mean base value.

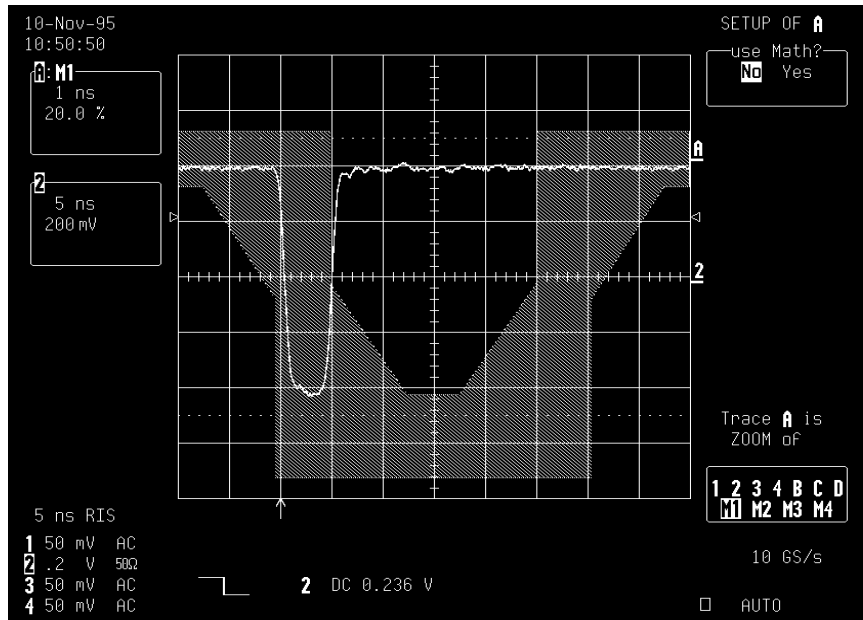

The mean top value accepted by the mask and the mean base value of the mask are shown, respectively, as the upper and lower horizontal dotted lines on the screen. The difference between the two represents five 20% divisions.



This screen displays the vertical unit of the mask:

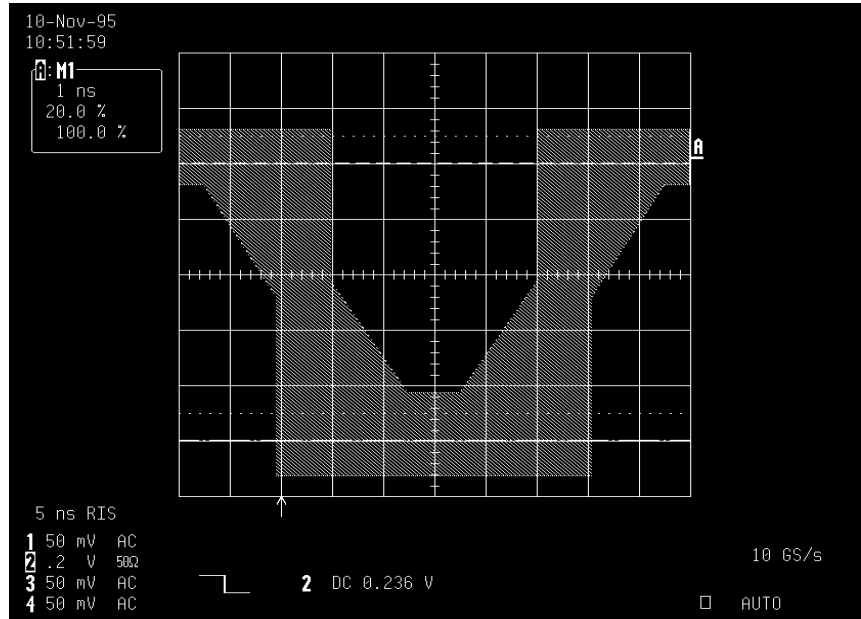

STEP 8 

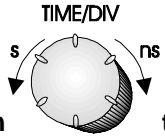
Turn  to obtain the same timebase for both trace and mask and match one to the other.

STEP 9 

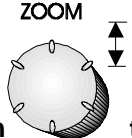
Turn  to position the trace so that its mean-top and mean-base values correspond to those of the mask.

Telecom Mask Testing

Later, if you had a weak signal the screen might display:

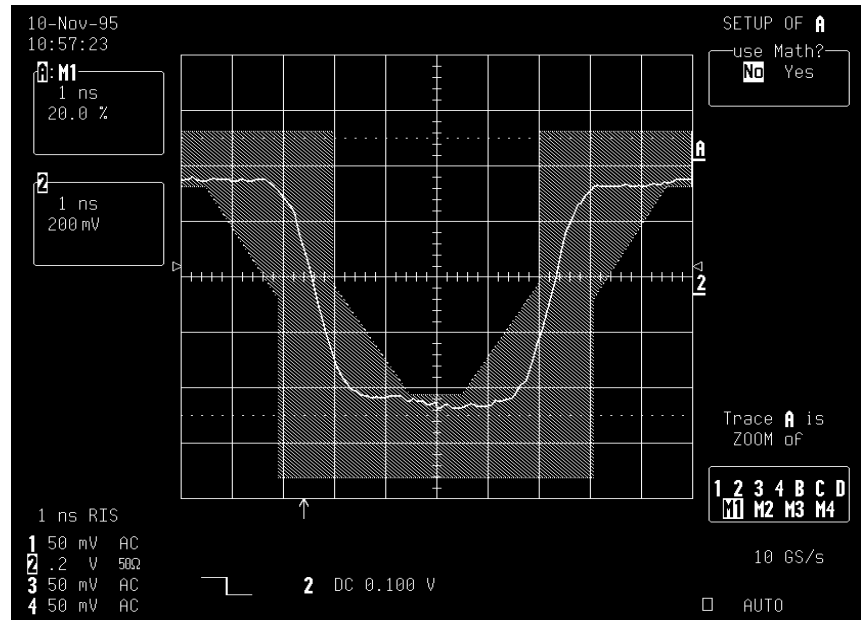

STEP 10 

Now, press  to do the test.

Then press the  to select "Parameters".

STEP 11 

Press the  to select "Pass".

This enables the test against masks or a parameter value to be made. This test should begin with "testing" turned to "Off". Once the tests are set up, testing can then be turned "On".



The screen will then display:

Note: The test status is shown on the first line under the grid. The number of acquisitions that passed the test and the total number tested are given. In this example, 40 of 61 acquisitions passed the test. Shown at the end of the same line is the pass or failure of the current acquisition. The lines beneath indicate what has been tested; some CH 1 parameters are tested by default. These lines can be changed by pressing the appropriate menu button for "CHANGE TEST CONDITIONS" (see next step), whereby the parameter or mask to be tested can be specified. Here only one line — CH 2 against the mask displayed as trace A — will be defined. To stop or restart the test, press the corresponding menu button to select "On" or "Off" from the "testing" menu.

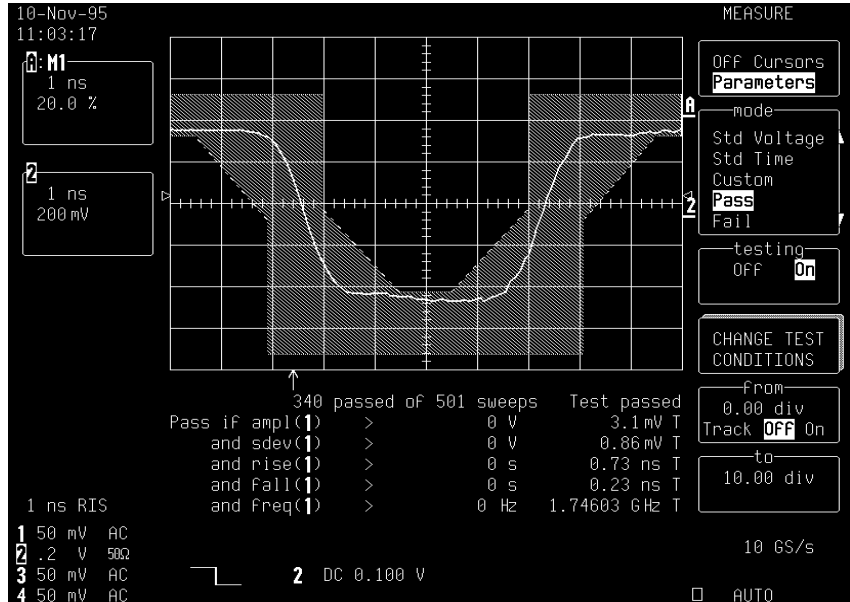

Tips: The test is performed only on points between the two vertical cursors. These cursors can be set by turning the upper and lower cursor knobs for the left and right cursors, respectively. The test is applied on all acquired points by default.

STEP 12

Press the corresponding menu s for "CHANGE TEST CONDITIONS", then for "DELETE ALL TESTS", and then to select "Mask" from the "Test on" menu.

Telecom Mask Testing

The screen will display:

Note: The test description appears on the first line. At this stage, the test is specified as: "Pass" if all the CH 1 trace points are inside the mask stored in Trace D.

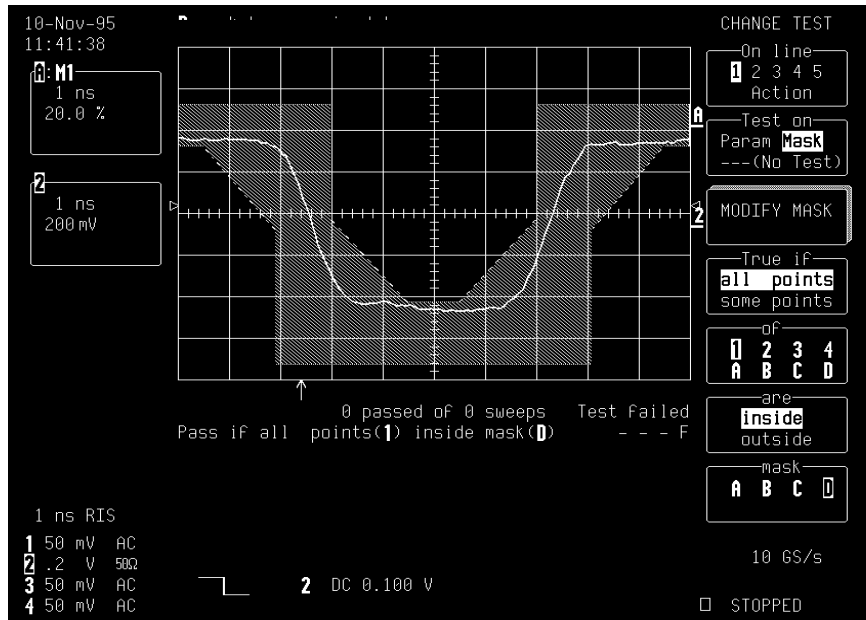

STEP 13

Press the s to select "2" and "A" from the "of" and "mask" menus. CH 2 and Trace A will be tested.

Now press  to run the test.

Measuring Skills

The screen will now display:

Note: To reset the test, press the CLEAR SWEEPS button. Several conditions can be specified in testing by pressing the appropriate menu buttons — “all points” or “some points” may be selected from the “True if” menu, and “inside or “outside” the mask from the “are” menu.

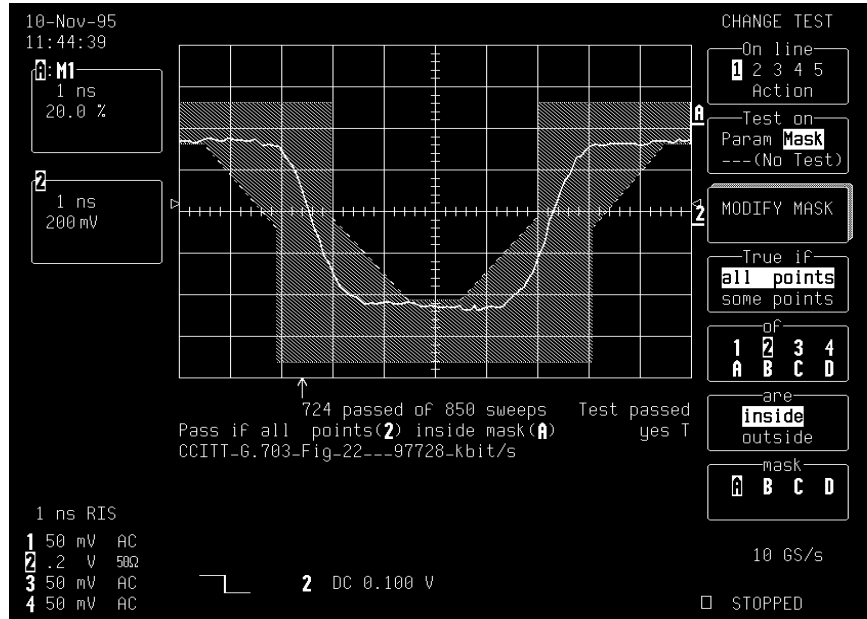

Tips: Whether the test is a “Pass” or “Fail”, any or all of the following can be activated by selecting from the “CHANGE TEST” menus:

- Stop capturing further signals
- Dump the screen image to a hard-copy unit
- Store selected traces to internal memory, memory card (optional), or floppy (optional) or hard disk
- Sound a beep
- Emit a pulse on the CAL BNC.

Telecom Mask Testing

The final screens in this tutorial display selections from the "CHANGE TEST" "Action" menus.

Note: To carry out one or more of these actions, make a selection from the "If" menu — to set whether the action or actions are to be carried out in the case of a Pass or a Fail — and then press the appropriate menu buttons to make the desired selection from the "Then" and "Stop" menus.

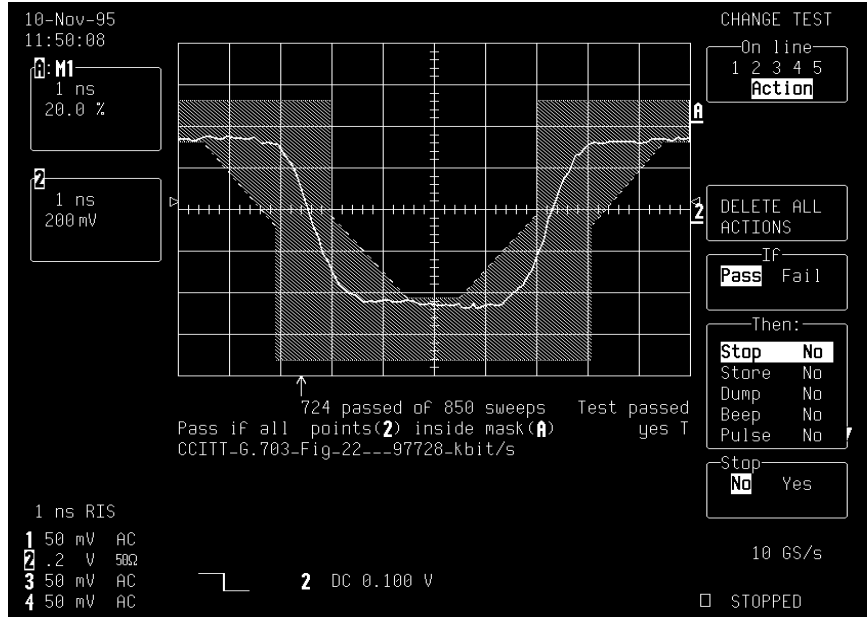



Measuring Skills

Note: With **“Store Yes”** selected, if the test is a Pass then Trace 2 will be stored to floppy.

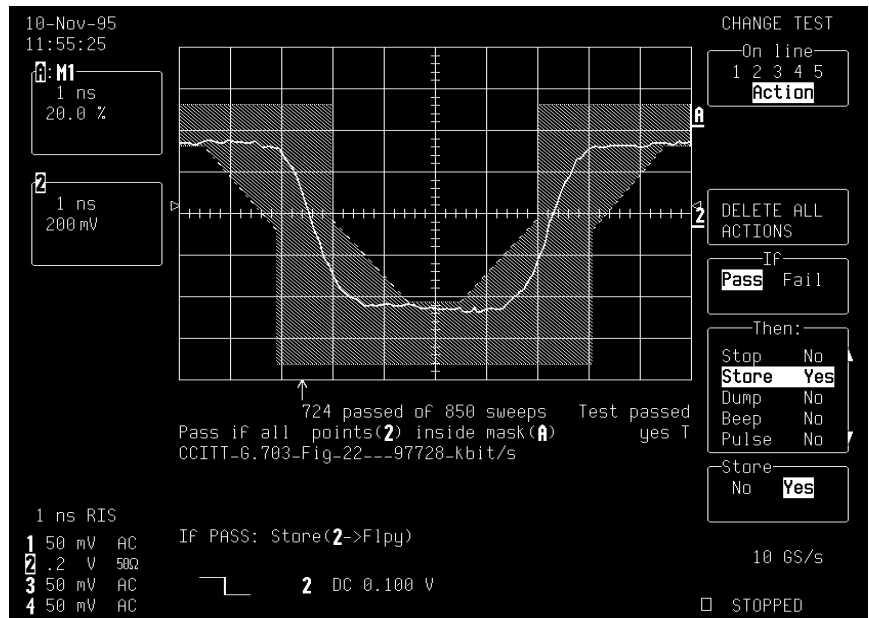

Storing to Removable Hard Disk

Your scope offers many options for automatic storage of acquisition traces to mass storage media, including floppy and memory card in the scope's front-panel drives. Another is the portable PC Card hard disk drive (HDD)*, a fast, removable, compact storage medium for saving and retrieving waveforms and instrument settings. Its adapter is located at the rear of the scope. Used together with the LC's Auto-Store function, it stores automatically after each acquisition.

Hardware Required

HD01 Type III Hard Disk Adapter option (available for all LeCroy oscilloscopes).

Application Setup

Connect the waveform to be stored on CH 2.

Insert the PC Card HDD in the adapter located at the rear of the scope.

Perform this acquisition after carrying out any of the measurements in this section of the guide. An example signal is provided.

* The PC Card hard disk drive is fully compatible with the computer industry's PCMCIA and JEIDA standards.





Measuring Skills

STEP 1 

Press  to complete the acquisition to be stored on the hard disk drive.

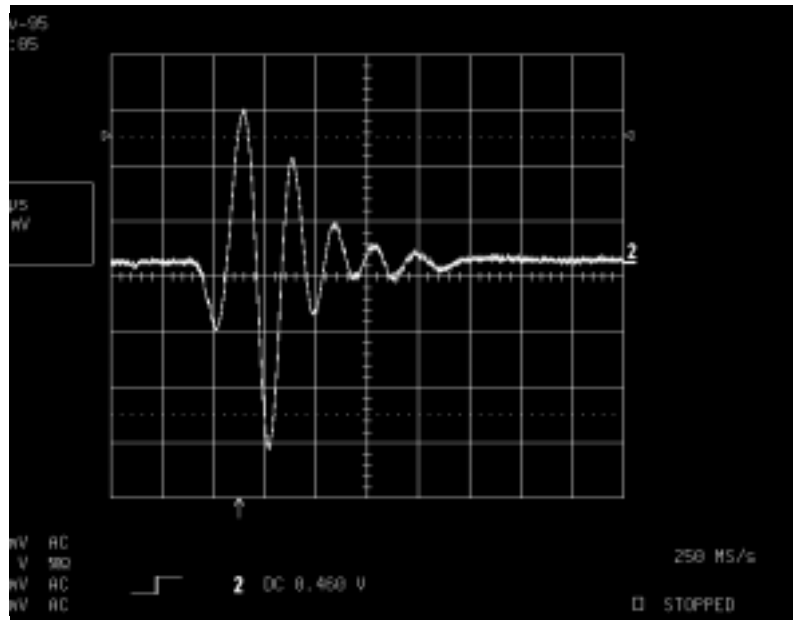
The screen will display:



STEP 2 

Now press 



PC Card Hard Disk Drive (HDD)

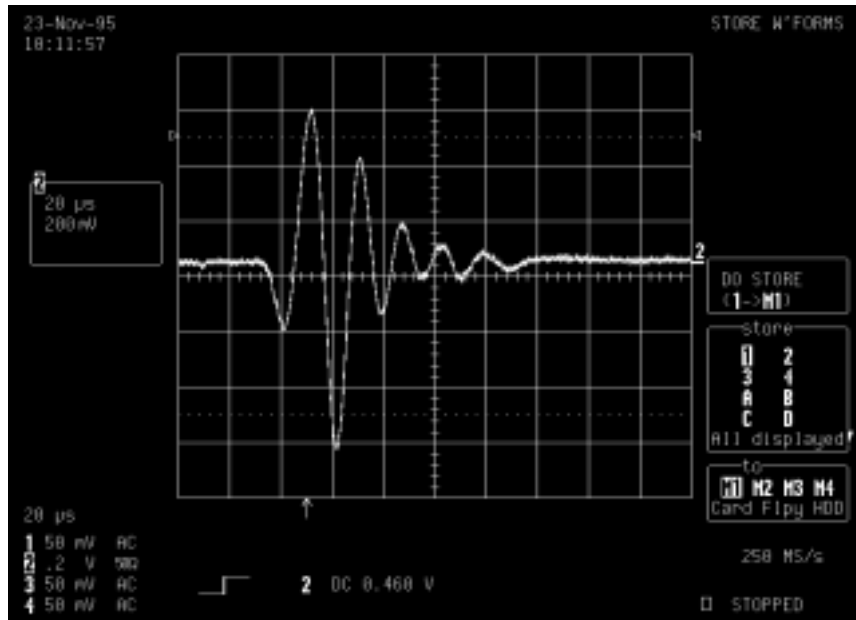

The screen will now display:

Note: The trace stored is generally CH 1 by default, along with target M1, a volatile internal memory. Depending on which mass-storage option or options are installed in the scope, the final box in the on-screen menu column will list a variety of waveform storage media. Here the menu offers "Card" (PC Card memory card option MC01), "Flpy", and "HDD" (PC Card Hard Disk Drive HD01). After selection of the particular storage medium, the procedure described in Steps 3–5 is the same for all.



STEP 3 

Press the  or turn the upper  to select "2" from the "store" menu

Then use the  or the lower  to select "HDD" from the "to" menu.



Measuring Skills

The screen will then display:

Note: When “HDD” is selected, a variety of new menu items appear. They are: the total size of the inserted PC Card hard disk drive — in this case, 128 511 kB; the amount of space free on the hard disk drive — here, 127 194 kB; the name of the HDD directory in which the files will be stored — shown is the default file LECROY_1.DIR”, created by the scope when a file is stored; and the Auto-store menu, whose description concludes this tutorial. Each time a trace is stored, the “Free” value is updated. The scope has a pre-defined naming convention for the eight-character file names. For manually stored waveform files, the format is Stt.nnn — where “tt” defines the trace name of C1, C2, C3, C4, TA, TB, TC, TD, and “nnn” denotes an automatically assigned, three-digit decimal sequence number starting at 001.

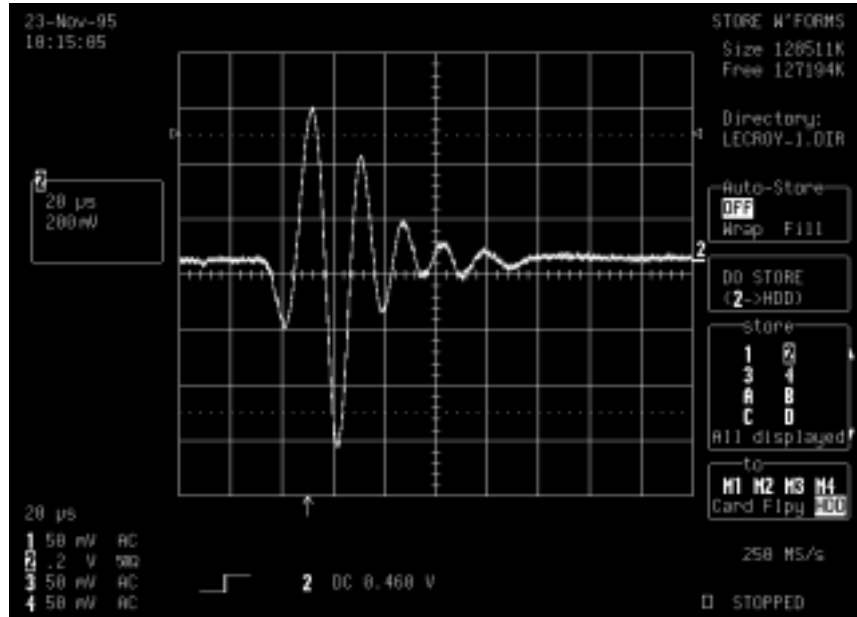

STEP 4

Press the corresponding menu  for “DO STORE” to store the acquired signal on the hard disk drive.

A message confirming that this has been achieved — such as: “2 stored to SC2.001 on LECROY_1.DIR of HDD” — will be displayed at the top of the screen.

PC Card Hard Disk Drive (HDD)

Auto-Store

When Auto-Store is selected, the waveform is stored automatically after each acquisition. Two varieties of Auto-Store are available:

“**Fill**”, which stores the acquired waveform until the storage medium (PC Card hard disk drive, floppy or memory card) is completely full; and

“**Wrap**”, which stores continuously to the chosen medium, while overwriting the oldest autostored files in a ‘first in–first out’ fashion.

STEP 5

Press the corresponding menu  to choose — for this example — “**Wrap**” from the “Auto-Store” menu.

The screen will display:

Note: In Auto-Store mode, the word “RECORDING” is displayed under the grid. If “FILL” is selected and default names are used, the first waveform stored will be Axx.001, the second Axx.002, and so on, until the medium is full, the file number reaches 999, or more than 2040 files are stored in the current working directory. If “WRAP” is selected, the oldest autostored waveform files will be deleted whenever the medium becomes full. Remaining files are then renamed — the oldest group of files becoming Axx.001, the second oldest “Axx.002”, and so on.

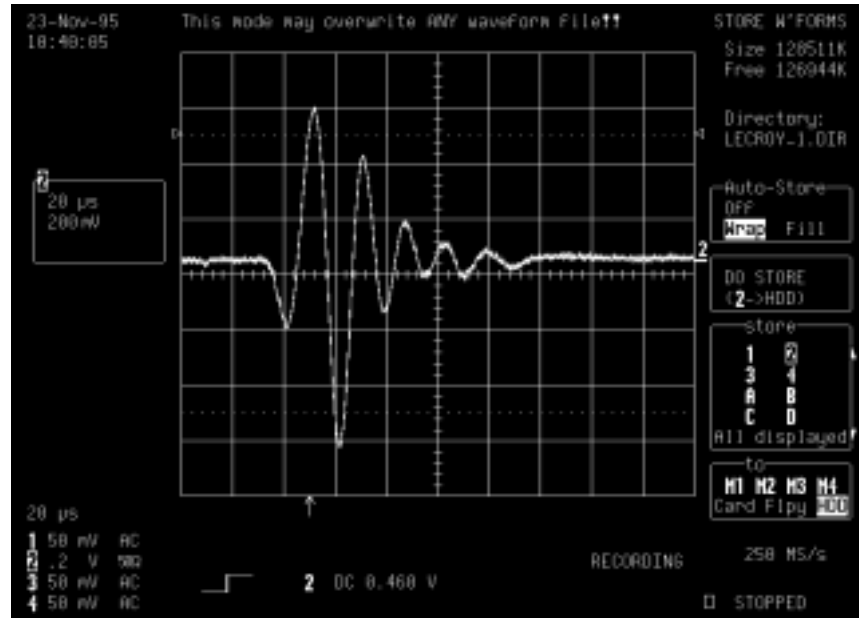



Calculating on Long Waveforms

Your scope either already is or can be fitted with long-memory hardware that provides maximum processing power, upgrading to 64 megabytes (MB) the RAM (Random Access Memory) of scopes possessing 16 MB of standard or boosted processing RAM*.

This tutorial shows how the 64 MB processing memory can be used to handle longer FFTs as well as multiple long-waveform zoom, math and storage.

Hardware Required













A LeCroy color digital oscilloscope with 64 MB of memory, fitted either as standard or as an option, depending on the model.

Application Setup

Connect the signal to be measured to CH 2 and adjust the timebase to give a waveform of one million points. The signal to be acquired here is an example two-million-point acquisition, but acquisitions of up to eight million can be made, depending on the scope model.

* Around 1.5 MB RAM is used by the operating system, with the remainder normally available for waveform storage, zoom, advanced math and FFT.

Long Waveforms

- STEP 1**  Reset: press , the top  and  simultaneously.
Then press  to turn off Trace 1.
- STEP 2**  Press , then the corresponding  to select from the “Coupling” menu the coupling matching the source’s impedance — 50 Ω.
- STEP 3**  Press  again.
- STEP 4**  Press  to stop the acquisition.
Then 

At the top of the column of TIMEBASE menus on the next screen, is shown the number of points acquired — 10 000 samples for this example. At the same time, the “Record up to” menu, at the base of the column, shows the acquired sample limit set by the user — 50 000 in this case.

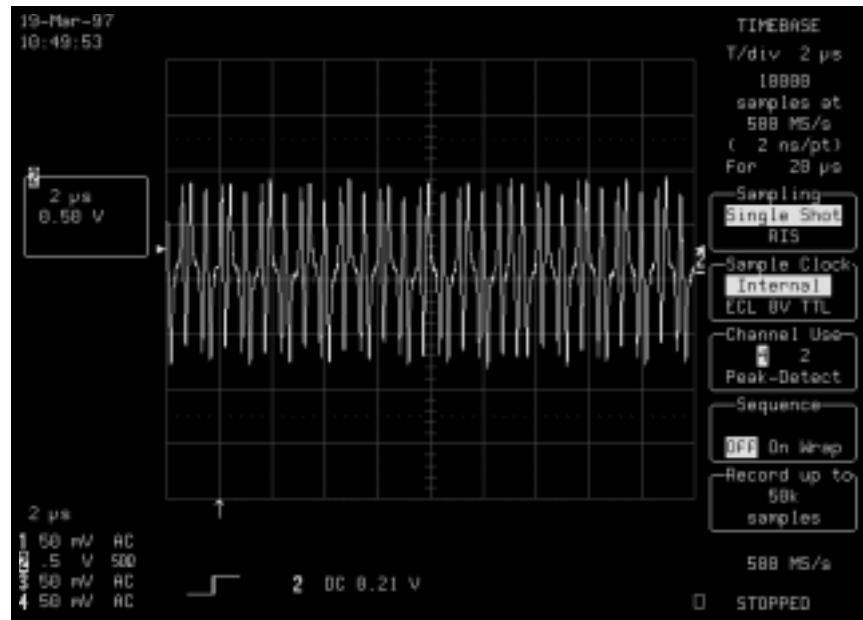

STEP 5

Turn the lower 'menu'  so that the "Record up to" number of samples is set to at least "1M" points — for this example it is set to "2M".

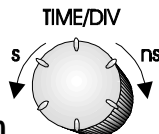

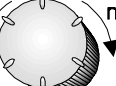
Turn  in order to slow down the timebase, and obtain more time per division, until the number of acquired points displayed is the same as in this example — "2M" points.

Press  to perform a single two-million-point acquisition.

Long Waveforms

The screen will now display:

Note: With the long acquisition memory, the maximum sampling rate (here, 500 MS/s) and thus the scope's full bandwidth is maintained at many more timebase settings than are possible with short-memory scopes. Particular advantages include:

- greater waveform detail
- high zoom factor
- protection against aliasing — improved time resolution
- wider frequency spectrum.

(See the LeCroy Application Note ITI 008 for details).

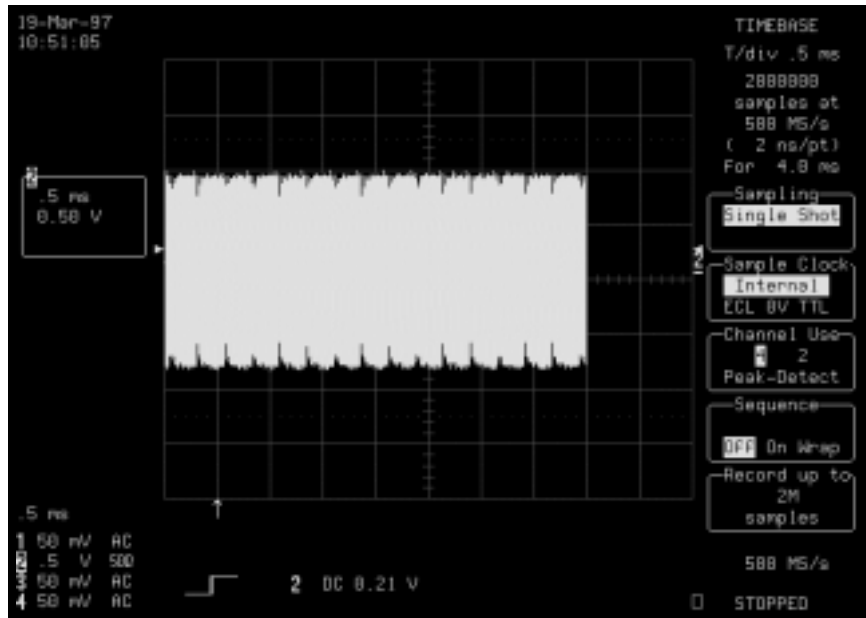

STEP 6

The next step illustrates just how practical is 64 MB memory processing — zooms or functions can be acquired on all two million points of the trace acquired in the preceding steps.

Press  **DISPLAY**, and then the  to select “**Quad**” from the “Grids” menu.



Measuring Skills

The screen will display:

Note: Functions or zooms can be selected on any channel or trace. The scope allows display of four different traces in as many grids, while preserving eight-bit resolution.

The grid now has only eight divisions because the capture of two million points with a sampling rate of 500 MS/s gives a window time acquisition of 4 ms. The sole possibility of displaying a 4 ms acquisition is to use eight divisions with a timebase of 0.5 ms/div.

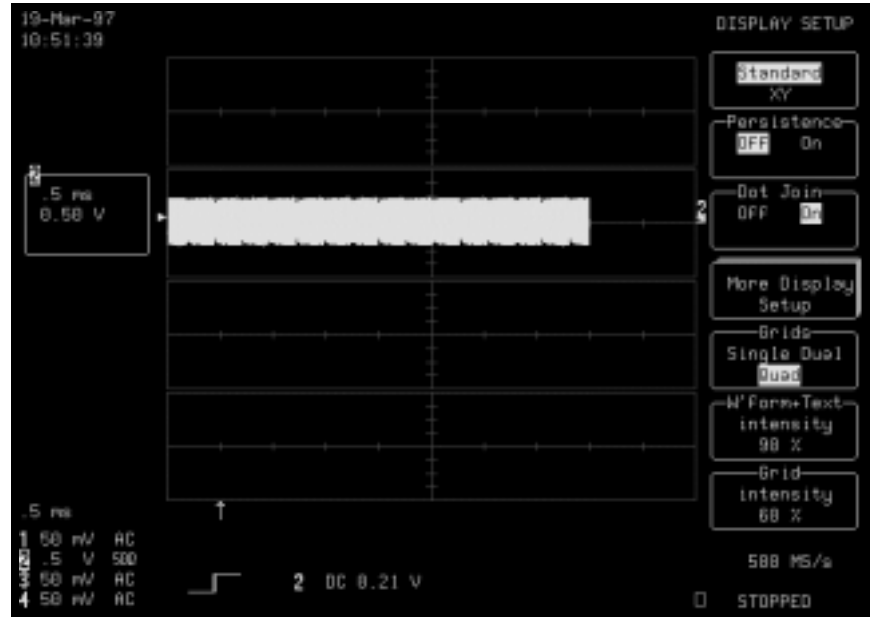

STEP 7 

Press 

Then turn the lower 'menu'  to select 10 M points ("max points 1000000") in the "for Math use" menu.

Long Waveforms

The screen will then display:

Note: The limit in the number of points must be equal to or higher than the actual number set in order to ensure performance of the function on all acquired points. This limit applies to all set functions or zooms, of which some may be set to reduce the number of points implied where processing memory size limitations apply — certainly not the case when the 64 MB option is installed!

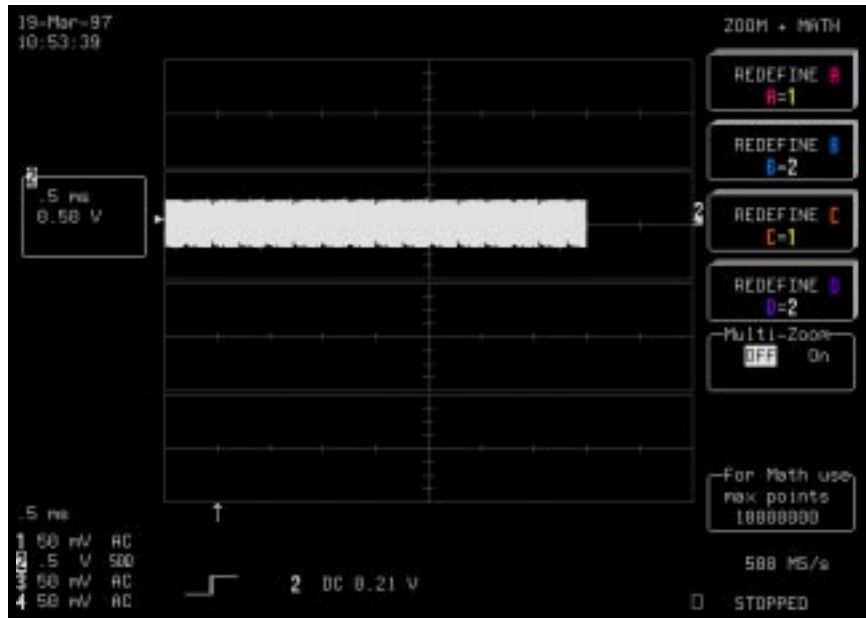

STEP 8

Press the corresponding menu  for “REDEFINE B”.

Turn the lower ‘menu’  to select “2”.

Then press  to turn on Trace A.



Measuring Skills

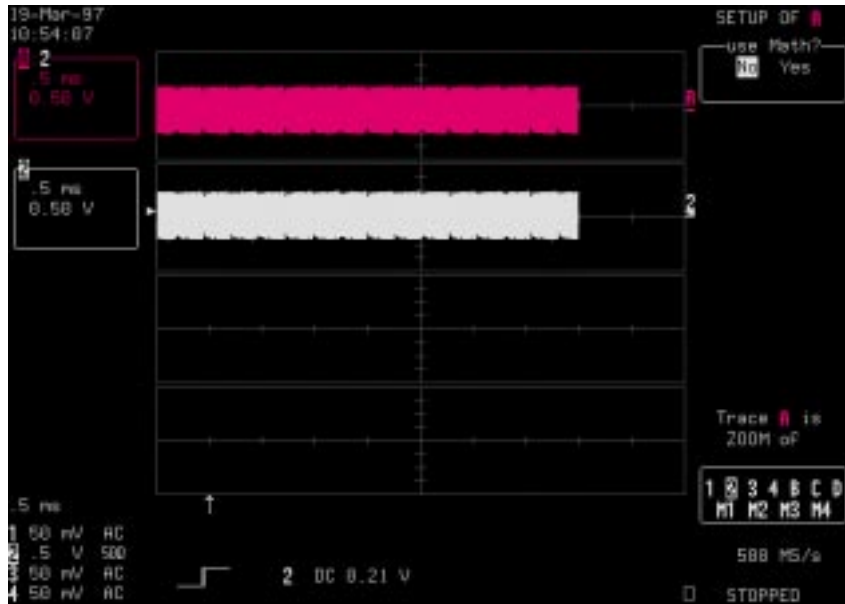

The screen will display:

Note: With Step 8 Trace A will be displayed as the zoom ("use Math?" "No") of CH 2, indicated with the bottom menu in the "SETUP OF A" menu column.



STEP 9

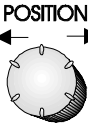

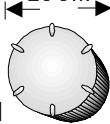
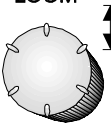
Use  and , and  and  to select the original signal selection, the timebase (horizontal zoom) and the amplitude (vertical zoom). This will enable the selection of a portion of the original signal and expansion of that portion vertically or horizontally.

Long Waveforms

The screen will then display a zoom (100 times) of CH 2 that indicates a zone of interest, as shown here:

Note: The selected section is shown on the original trace as reinforced video. The RESET button cancels all the zoom changes and redisplay the original trace

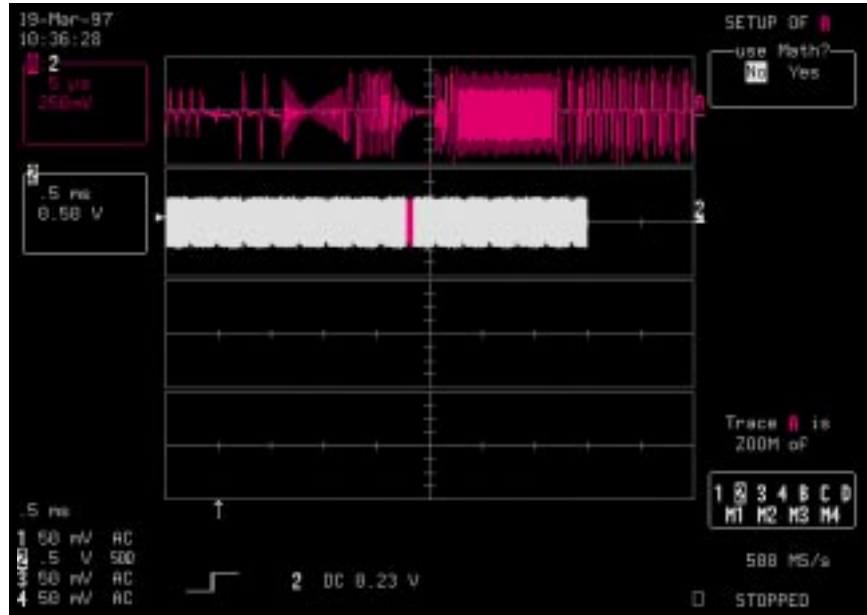

Tips: To check how much memory is being used and how much is still available, press the **SHOW STATUS** button, then press the corresponding menu button until **“Memory Used”** is selected, as shown on the next screen. The **“Memory used for storage of records”** readout at top-left-of-screen details the amount of memory taken up, the amount free and the total of memory.

When the performance of a function requires more processing memory than available, the message insufficient data memory (see show status) appears.



Measuring Skills

```
19-Mar-97
16:00:38

Memory used for storage of records

A      50 048 bytes
Free   65 511 808 bytes
Total  65 561 856 bytes
```

Acquisition System
Text & Times
WaveForm
Memory Used

M1 empty

M2 empty

M3 empty

M4 empty

To free some memory, you can

- . clear Memory waveforms
- . reduce the number of points used for Math (MATH SETUP)
- . reduce the number of samples in the Record (TIMEBASE SETUP)
- . turn off traces or parameters

CLEAR INACTIVE

500 MS/s

STOPPED

STEP 10 

Press 

Then press the  for "REDEFINE B".

Next, press the  to select "Yes" from the "use Math?" menu.

And turn the lower  to select CH 2, on which the trace is acquired.

Long Waveforms

The screen will now display

Note: A variety of selections can be made from the "Math Type" menu, including:
Standard — summed averaging up to 1000 sweeps, arithmetic operations (add, subtract, multiply, divide, negate, identity), and the $(\sin(x)/x)$ interpolation function;
WP01 — summed averaging up to one million sweeps, continuous averaging up to 1024 sweeps, reciprocal, rescale, absolute value, derivative, integral, logarithm (e) and Logarithm (10), exponential (e) and exponential (10), square, square root;
Enhanced Resolution — digital filtering allowing 0.5–3-bit vertical resolution improvement; **WP02** — frequency domain analysis (FFT and FFT power averaging), as well as rescale in both the time and frequency domains; and with **WP03** installed — histogram function for over 40 different parameters and 18 histogram parameters.

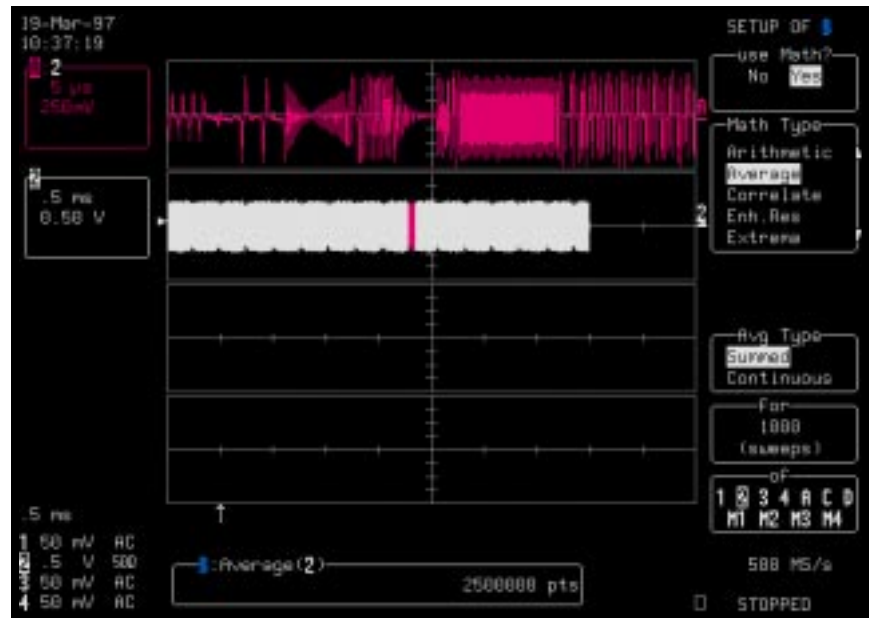

Each of the functions noted here uses processing memory according to the algorithm applied. An FFT — for example — consumes up to ten times the size of the original acquired signal. Thus, for a two-million-point trace, the minimum processing memory required would be 20 MB.

STEP 11

Press either of the corresponding s to select a function for Trace B — FFT, for example, Trace B=PSFFT(2). The trace must be displayed for the calculation to be performed...

Press  to turn on Trace B.



The screen will display:

Note: On long traces, it can take several minutes to calculate the data of functions such as FFT. The information "B:Math" is displayed at the base of the screen while the scope is calculating the function that is to be displayed and stored in the memory.

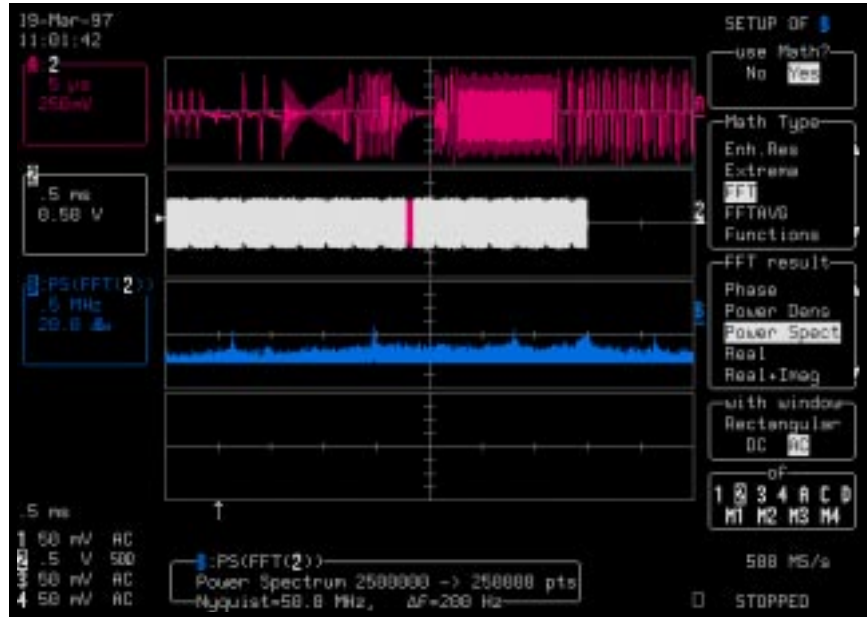

Tips: Again, in order to check how much memory is being used and how much is still available, press the **SHOW STATUS** button, then press the corresponding menu button until "Memory Used" is selected.

STEP 12

Same as for Step 11, but this time:

Press the menu s to select a function for Traces C and D, then for selecting different functions on Trace 2 and displaying the result.

Long Waveforms

Tips: Four traces can be displayed simultaneously, as shown on the screen below. The original signal need not be displayed for calculations to be performed on it. And four functions can be performed on either of the originally acquired traces at the same time.

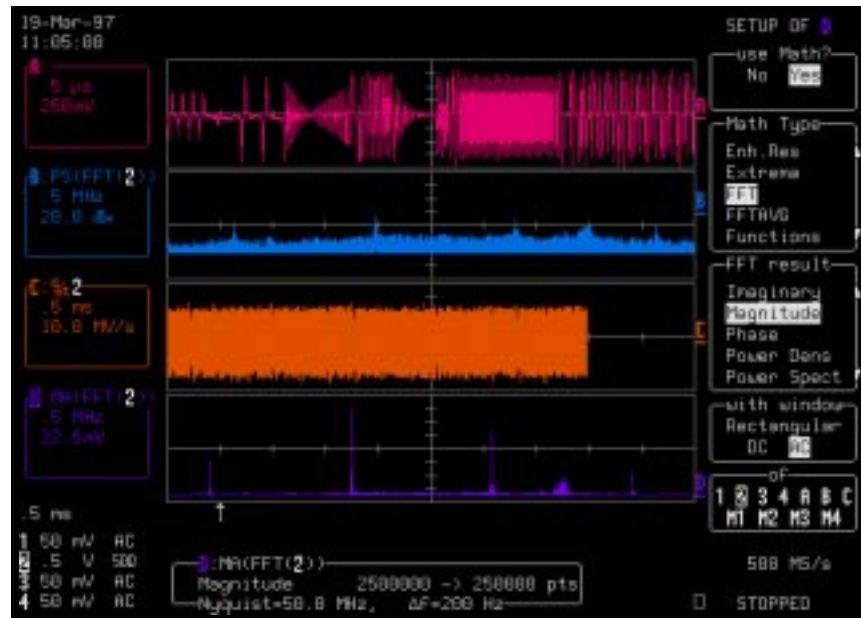



Measuring Skills

Note: In this final example, four functions performed on CH 2 are displayed. However, CH 2 itself is not displayed. The "Memory Used" display details the processing memory used in performing all the calculations.

```
19-Mar-97
16:41:30

Memory used for storage of records

 2      10 000 056 bytes
 A          50 048 bytes
 B      15 000 060 bytes
 C          5 000 028 bytes
 D      15 000 060 bytes
Free      20 511 220 bytes
Total     65 561 472 bytes
```

To free some memory, you can

- . clear Memory waveForms
- . reduce the number of points used for Math (MATH SETUP)
- . reduce the number of samples in the Record (TIMEBASE SETUP)
- . turn off traces or parameters

STATUS

Acquisition System
Text & Times
Waveform
Memory Used

M1 empty

M2 empty

M3 empty

M4 empty

CLEAR INACTIVE

500 MS/s

STOPPED







SMART Glitch-Capturing

Finding and capturing elusive glitches — faster-than-normal transitions or shorter-than-normal pulses in a signal — is simple with the Glitch SMART trigger. Signal source, coupling, level, width and pulse can be specified for the glitch search. The range of applications is vast, including digital and analog electronic development, telecommunications, automated testing equipment (ATE), electromagnetic interference (EMI), and magnetic media studies.

Application Setup



Connect the signal to be measured — here, for example, a 500 kHz sinewave with glitch — to CH 2.

STEP 1 

Reset: press , the top  and  simultaneously.

Then press  to turn off Trace 1.

STEP 2 

Press , then the corresponding  to select from the “Coupling” menu the coupling matching the source’s impedance — 50 Ω.



Measuring Skills

STEP 3 

Press  again, then 

The screen will display:

This screen shows a normal 500 kHz sinewave. Observing the signal during several acquisitions would reveal the occasional glitch. The goal of this measurement is to catch this event by setting a trigger adapted to it.

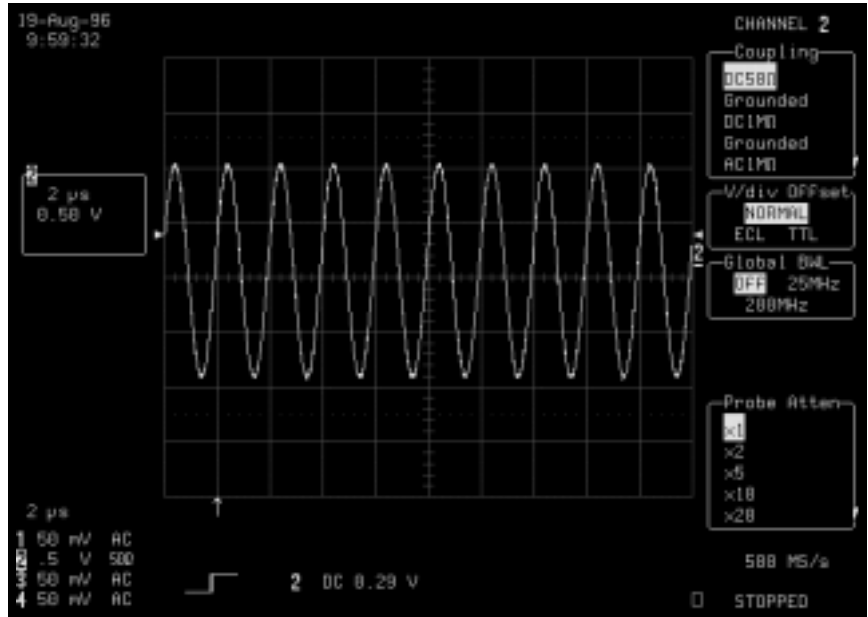

STEP 4 

Press 

Capturing Glitches

The screen will then display:

Note: “**Edge**” — for Edge Trigger — is selected by default. This trigger is described by **source** and **coupling** (see following list), as well as **slope** and **level condition** — the same parameters used to build up the SMART Trigger.

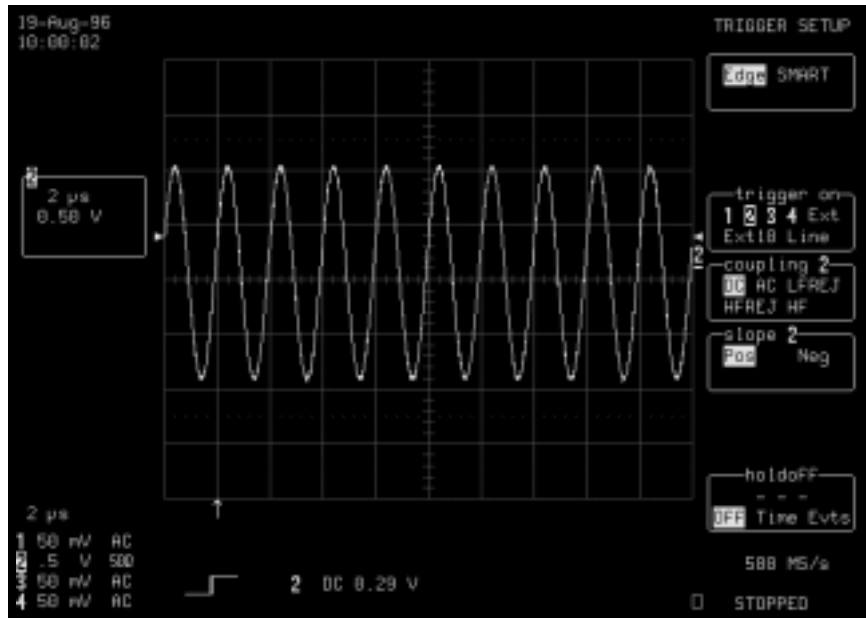

Trigger Source

The trigger source may be:

- The acquisition channel signal (CH 1, CH 2, CH 3 or CH 4) conditioned for the overall voltage gain, coupling, and bandwidth.
- The line voltage that powers the oscilloscope (LINE). This can be used to provide a stable display of signals synchronous with the power line. Coupling and level are not relevant for this selection.
- The signal applied to the EXT BNC connector (EXT). This can be used to trigger the oscilloscope within a range of ± 0.5 V on EXT and ± 5 V with EXT/10 as the trigger source. Or, on the **LC564 AND LC584 SERIES**, ± 1.2 V for EXT and ± 6 V with EXT/5 as trigger source.

Coupling

Coupling refers to the type of signal coupling at the input to the trigger circuit. The trigger coupling can be selected independently from the following options:

- **DC:** All the signal's frequency components are coupled to the trigger circuit for high-frequency bursts or where the use of AC coupling would shift the effective trigger level.
- **AC:** The signal is capacitively coupled, DC levels are rejected and frequencies below 50 Hz attenuated (< 10 Hz for the **LC564 AND LC584 SERIES**).
- **LF REJ:** The signal is coupled via a capacitive high-pass filter network, DC is rejected and signal frequencies below 50 kHz are attenuated (< 100 MHz for the **LC564 AND LC584 SERIES**). For stable triggering on medium- to high-frequency signals.
- **HF REJ:** Signals are DC-coupled to the trigger circuit and a low-pass filter network attenuates frequencies above 50 kHz. For triggering on low frequencies.
- **HF:** To be used only when necessary for triggering on high-frequency repetitive signals > 300 MHz, with a maximum trigger frequency of > 500 MHz (> 1 GHz for the **LC564 AND LC584 SERIES**). HF is automatically overridden and set to AC when incompatible with other trigger characteristics (and SMART triggers). Only one slope available.

STEP 5

Press the corresponding menu  to select “**SMART**”. The screen will display as shown next page:

Capturing Glitches

Note: The Glitch SMART Trigger is the particular variety selected by default. It will be used here, but pressing the menu button for "SETUP SMART TRIGGER" will show the other types of SMART Trigger available.

Source and coupling were set in the preceding steps. The slope can now be selected — "Neg" (negative) or "Pos" (positive). The icon displayed under the grid represents and describes the trigger setup.

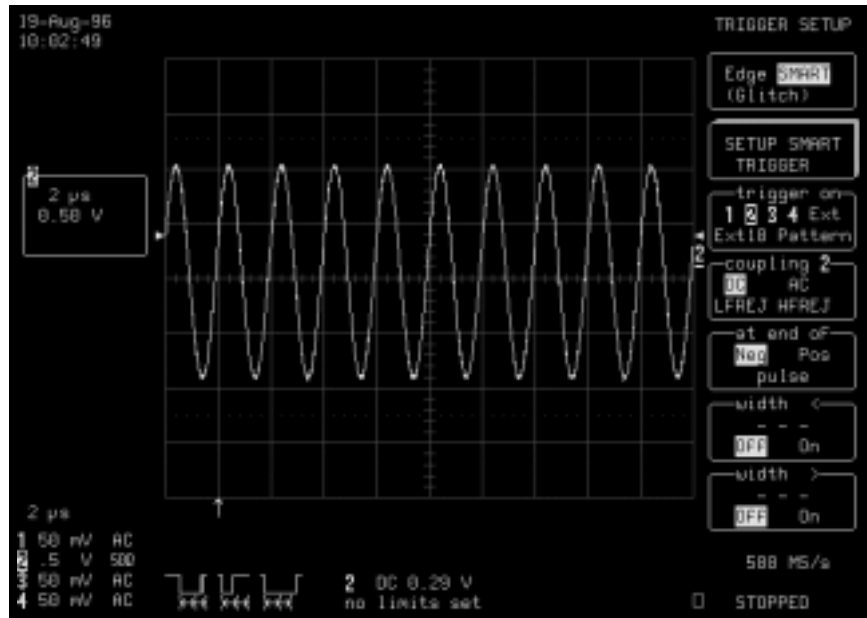

The next step is to set the trigger to capture the glitch on the current signal.

Here, the glitch's width is lower than the signal's. Thus the trigger needs to be set to a smaller width than that of the signal, whose own width depends on the DC trigger level. If that level is set at the middle of the sinewave, the width can be considered as the half period. However, if the level is higher, the signal's width has to be considered as being less than the half-period. Two microseconds is the period for our example sinewave. The DC trigger level is set, not at the middle of the sinewave, but where its width is about 800 ns.

Therefore, the Glitch SMART trigger ought to be on CH 2 at end of "Neg" pulse with a width of < 800 ns.



Measuring Skills

STEP 6

Press the corresponding menu  to select “On” from the “width<” menu.

Then turn the upper  to adjust the value in that menu to 800 ns.

The screen will display:

Note: “width<” can be also used in combination with “width>”. The two width limits are combined to select glitches within a window, low value<signal width<high values, or the two limits can be combined to trigger only on signals outside a window (see Capturing Rare Phenomena).

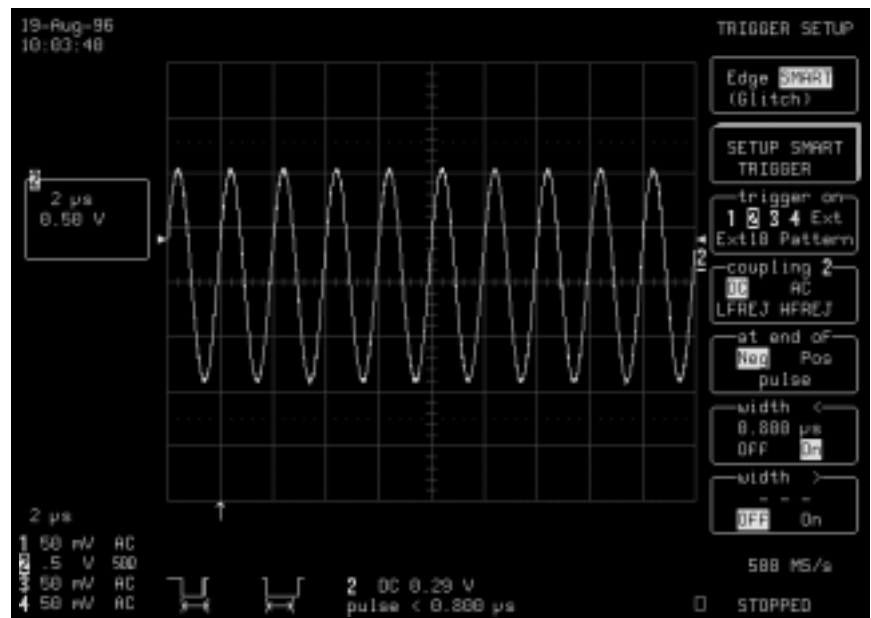

STEP 7

Press  to start the trigger.

Capturing Glitches

The screen will display:

Note: As shown on the screen this page, the scope always triggers on the glitch that affects the sinewave.

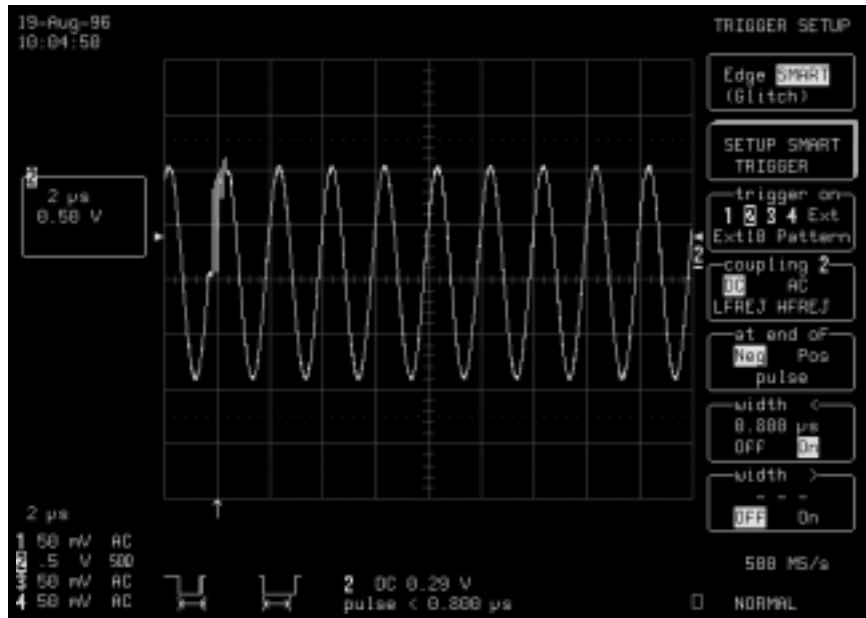

Tips: In order to be sure the scope captures the glitch, the trigger level has to be matched to the level at which the glitch appears.

In setting the Glitch trigger, it is helpful to first identify the glitch shape. Use Persistence (see 3-D Viewing with Persistence), as in the final screen.



Measuring Skills

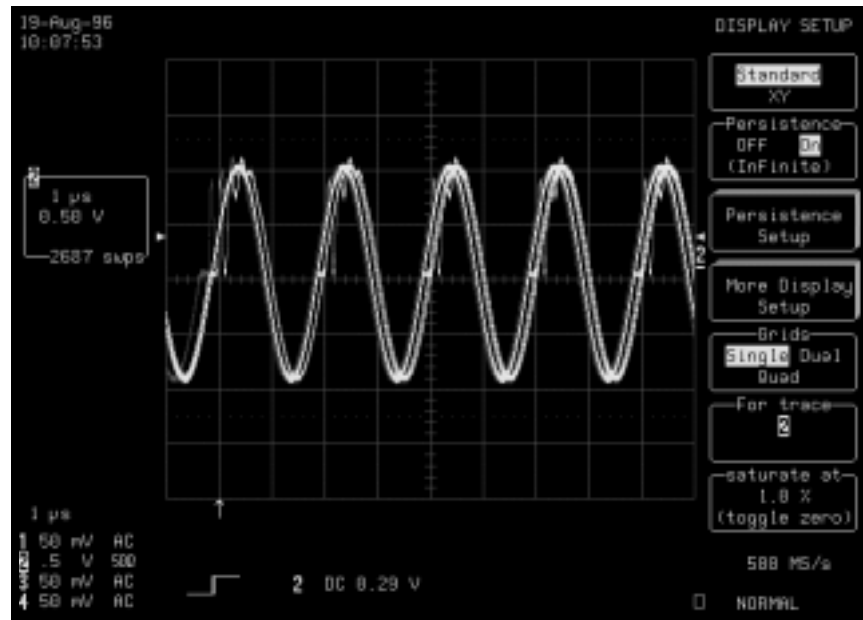

Capturing Rare Phenomena

LeCroy's SMART Trigger types are good at capturing rare phenomena (see *the Operator's Manual*). The Exclusion Trigger does this by triggering on all events different from the expected waveform — such as glitches and intermittent out-of-tolerance waveforms. In this way, the oscilloscope itself contributes to increased knowledge of exceptional waveforms, leading to their complete description. Here's how.

Application Setup



Connect to CH 2 a waveform whose multiple glitches, because of their low duty cycle, do not show up when the Edge Trigger or Persistence display is used.

STEP 1 

Reset: press , the top  and  simultaneously.

Then press  to turn off Trace 1.

STEP 2 

Press , then the corresponding  to select from the "Coupling" menu the coupling matching the source's impedance — 50 Ω.



Measuring Skills

STEP 3 

Press  again to display:

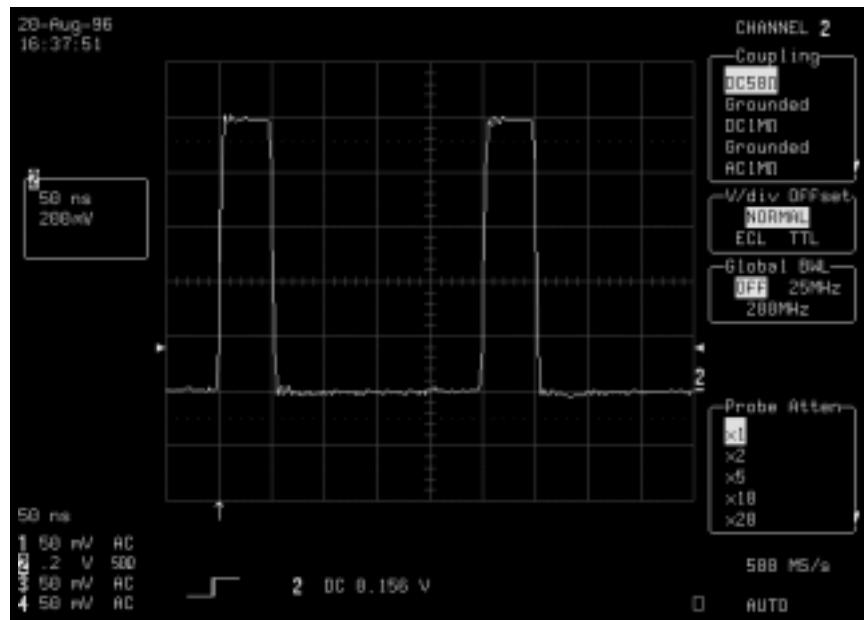

STEP 4 

Press  and then 

Rare Phenomena

The screen will now display:

Note: **“Edge”** — for Edge Trigger — is selected by default. This trigger is described by source and coupling, as well as slope, and level condition: the same parameters used to build up the SMART Trigger.

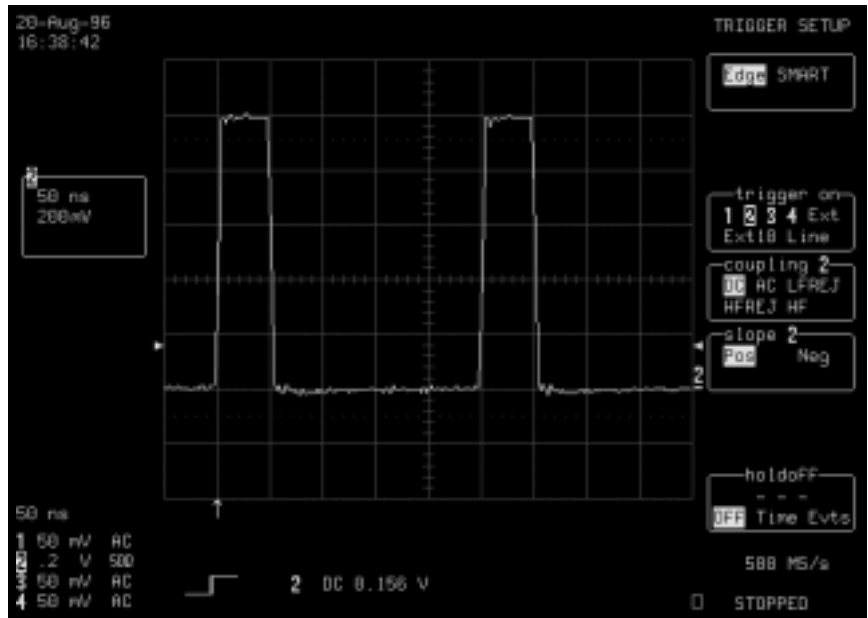

STEP 5 

Press the  to select **“SMART”**.



The screen will then display:

Note: The Glitch SMART Trigger is the trigger selected by default. It will be used here, but pressing the menu button for "SETUP SMART TRIGGER" will show the other types available. Both the Glitch and Interval Triggers include minimum and maximum timing limits, normally used to trigger on waveforms falling within those limits. The Exclusion Trigger uses these maximum and minimum limits to exclude triggering on certain waveforms. This allows the scope to avoid the deadtime inherent in triggering on 'normal' signals. While in Exclusion Trigger mode, the scope remains ready to trigger on abnormally shaped signals.

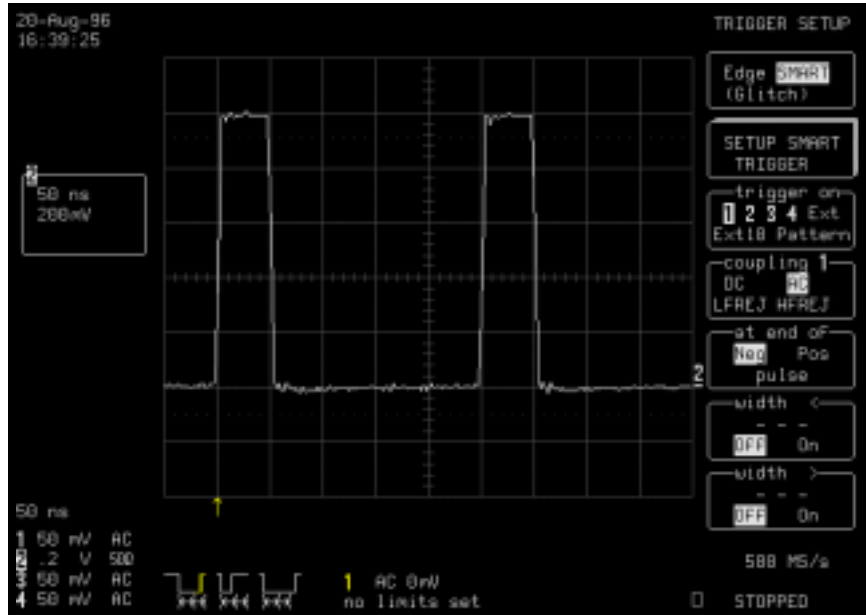

The next step and its various stages set up the Glitch SMART Trigger to eliminate nominal pulses having a width of 50 ns (one division). Thus only those waveforms that do not have pulse widths of 50 ns will trigger the oscilloscope.

STEP 6



Press the  to select "2" from the "trigger on" menu, and Trace 2 as source trigger, adjusting the trigger level to one division from the top of the pulse.

Press the  to select "Pos" from the "at end of" menu (in this case the pulses are positive).

And the  to select "On" from the "width <" menu.

Then turn the upper menu  to set the "width <" value to 47.5 ns.

The screen will now display:

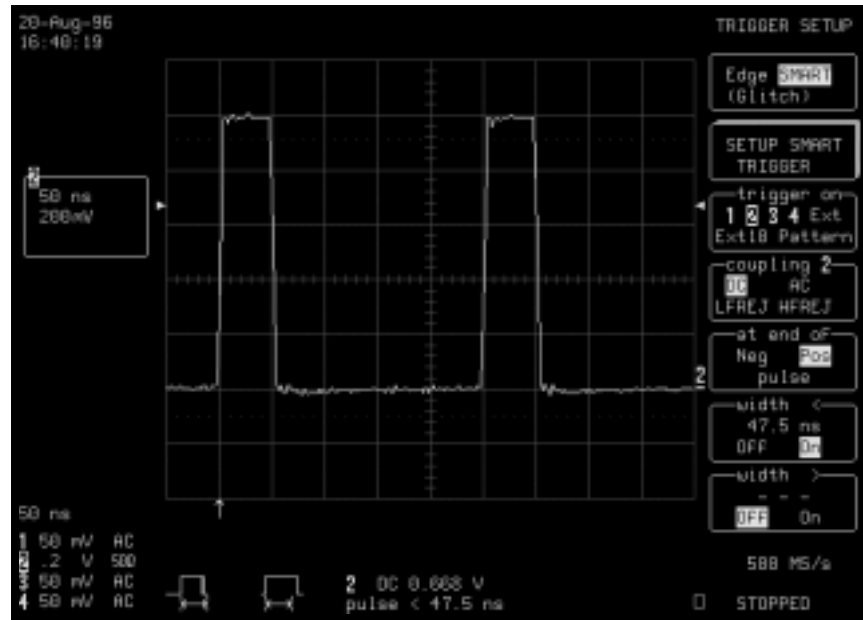

STEP 7 

Next, press the corresponding menu  to select "On" from the "width >" menu.

And turn the lower menu  to set this value to 52.5 ns.



Measuring Skills

The screen will then display:

Note how the icon describing the current trigger setup, shown under the grid, is updated.

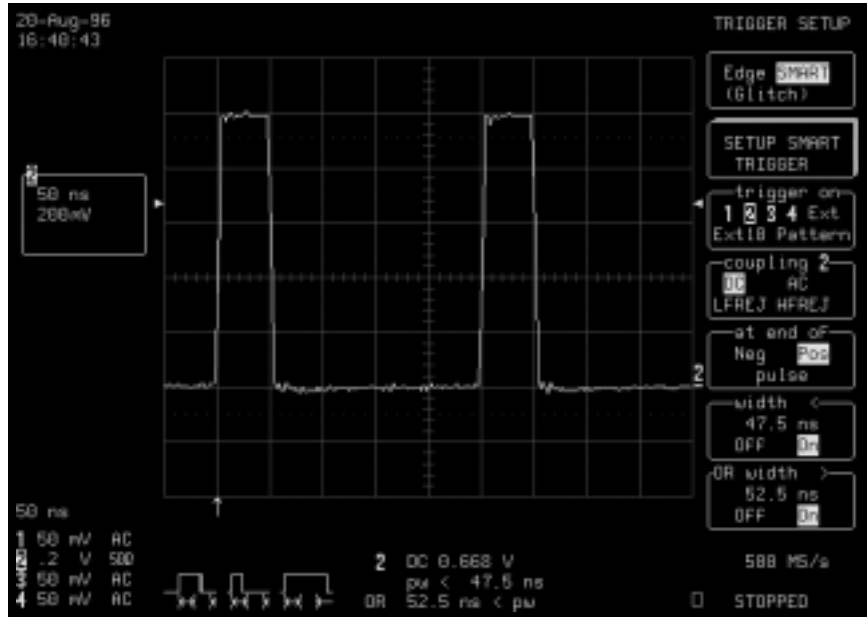

STEP 8

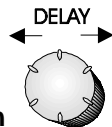

Turn  to set the trigger point close to mid-screen.

Then press  to activate the trigger.

The screen will display:

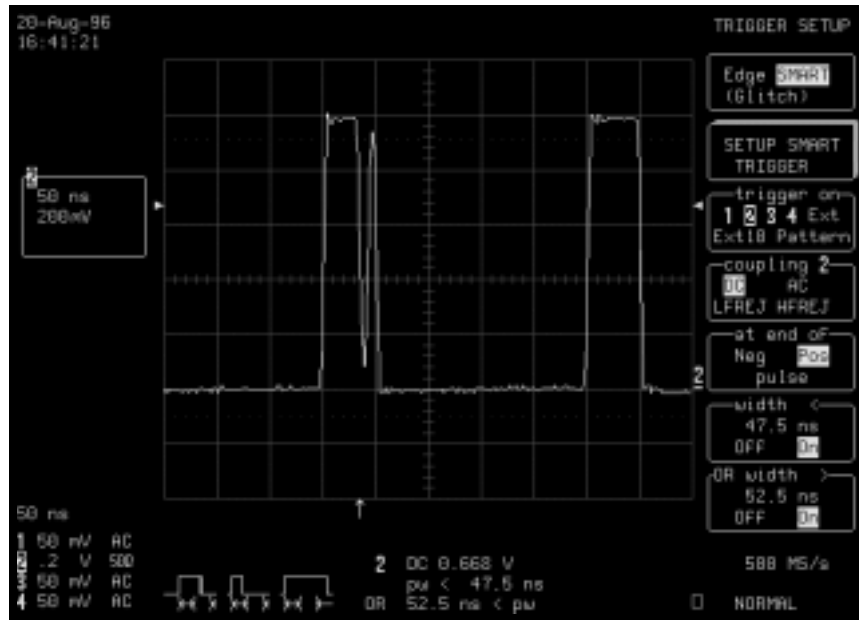

Tips: Persistence Mode can be used to show a history of the exceptional pulse acquisitions, set by pressing DISPLAY and then the menu button to select “On” from the “Persistence” menu — as shown on the next screen (see also 3-D Viewing with Persistence, page 3-31).

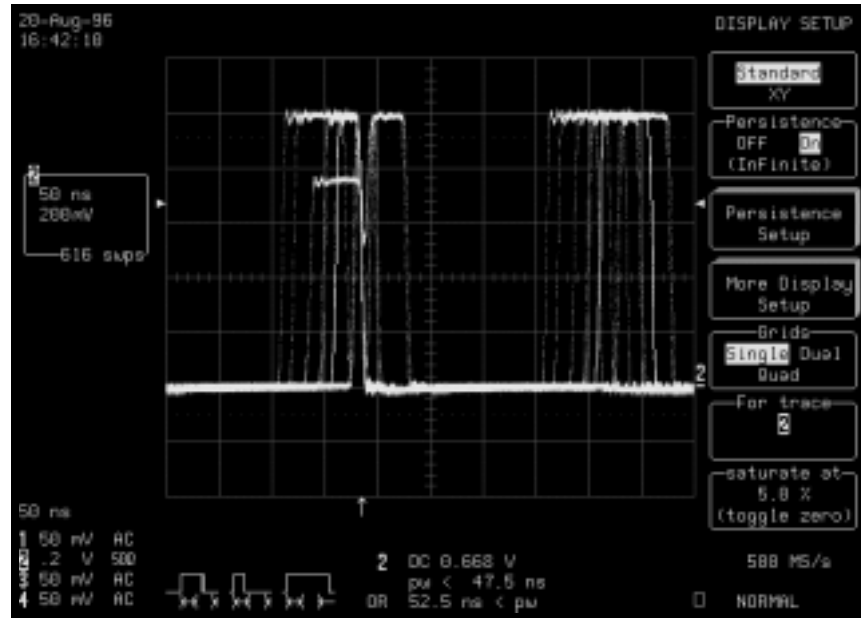

Tips: A further enhancement is obtained by combining the Exclusion Trigger with built-in Pass/Fail testing. The trigger speeds the acquisition of exceptional pulses, while the mask testing verifies the waveshape. Storing the waveform or printing the screen display can individually document each exceptional pulse.

Rare Phenomena

Waveform parameter statistics displayed under the grid provide additional information about the key waveform parameters for these exceptional pulses — as shown on the final screen, below. For instance, the parameter “width” shows the pulse width varying from 6.5 ns to 75.0 ns. Using this new information, the trigger setup can be changed to concentrate on acquiring pulses with specific characteristics.

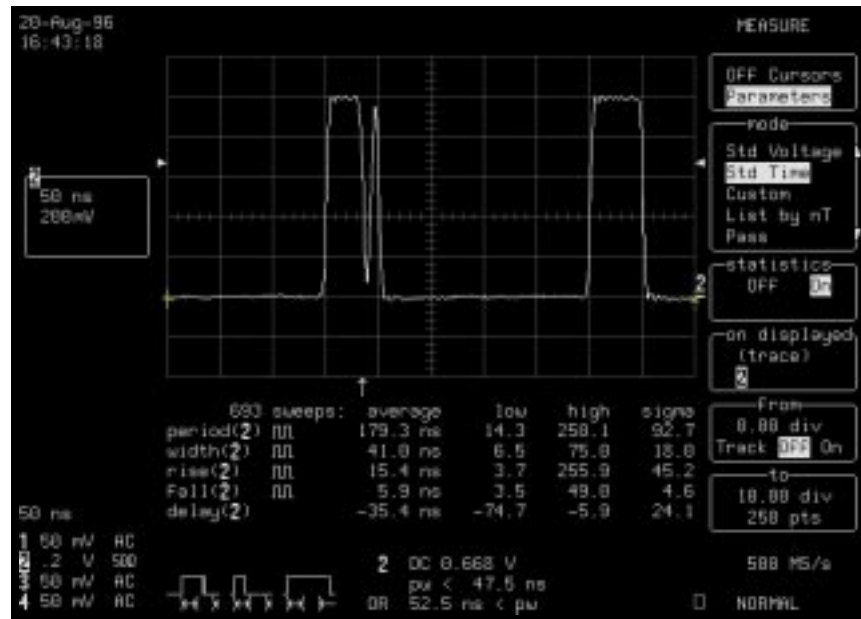







Triggering on Lost Signals

Another SMART function of LeCroy oscilloscopes is the Dropout Trigger. This trigger event is generated to make an acquisition whenever a signal becomes inactive for a selected time at the end of the timeout period, following the final trigger-source transition. Ideal for detecting interruptions in data streams (network hang-ups, microprocessor crashes and others), the Dropout Trigger is typically used to look for the ‘last normal’ interval in a lost signal.

Application Setup



Connect the signal to be measured — a 1 kHz squarewave — to CH 1.

STEP 1 

Reset: press  , the top  and  simultaneously.

Then press  to turn off Trace 2.

STEP 2 

Press  , then the corresponding  to select from the “Coupling” menu the coupling matching the source’s impedance — 50 Ω .

Lost Signals (Dropout Trigger)

STEP 3

Note: This screen shows the 1 kHz repetitive squarewave before the signal disappears.

AUTO
SETUP
Press  again to display:

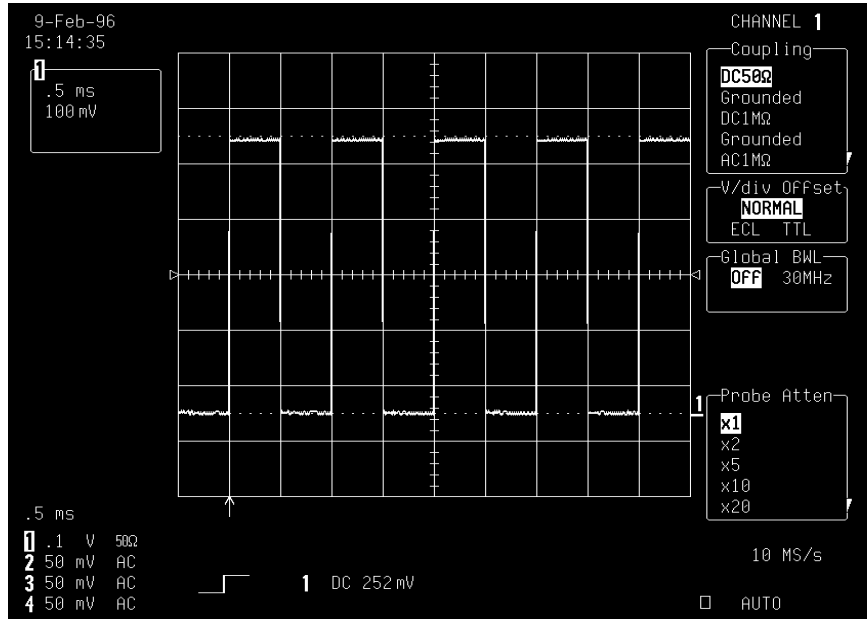

The following steps set the trigger to capture only the 'last normal' period of the signal and transient signal.

STEP 4

SETUP
TRIGGER
Press 



Measuring Skills

The screen will then display:

Note: “**Edge**” — for Edge Trigger — is selected by default. This trigger is described by source and coupling, as well as slope, and level condition — the same parameters used to build up the SMART Trigger.

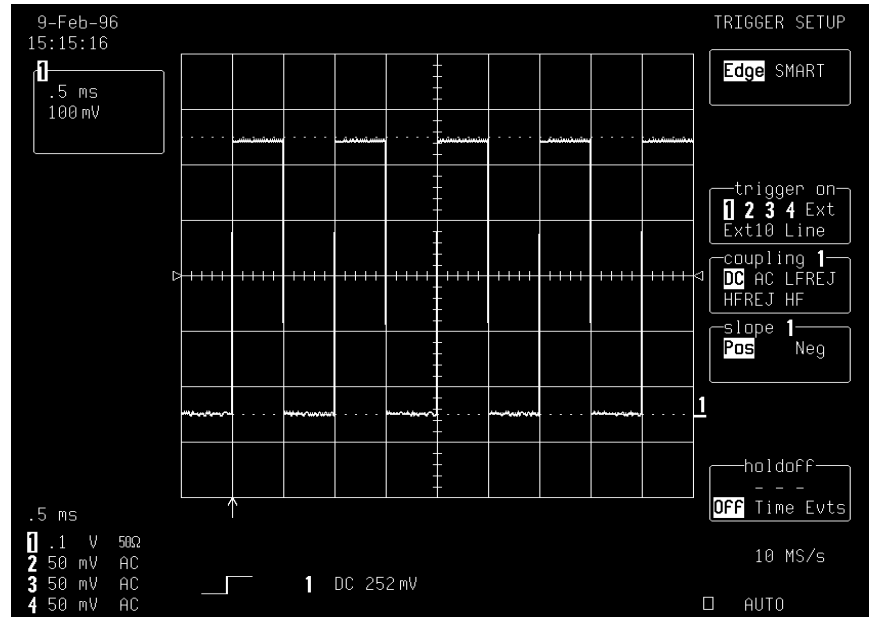

STEP 5

Press the corresponding menu s to select “**SMART**” from the top menu, then for “**SETUP SMART TRIGGER**”, and then “**Dropout**” from the “type” menu.

Lost Signals (Dropout Trigger)

The screen will display:

Note: The Dropout Trigger is used essentially for single-shot applications — usually with a pre-trigger delay. By default, the timeout is 25 ns.

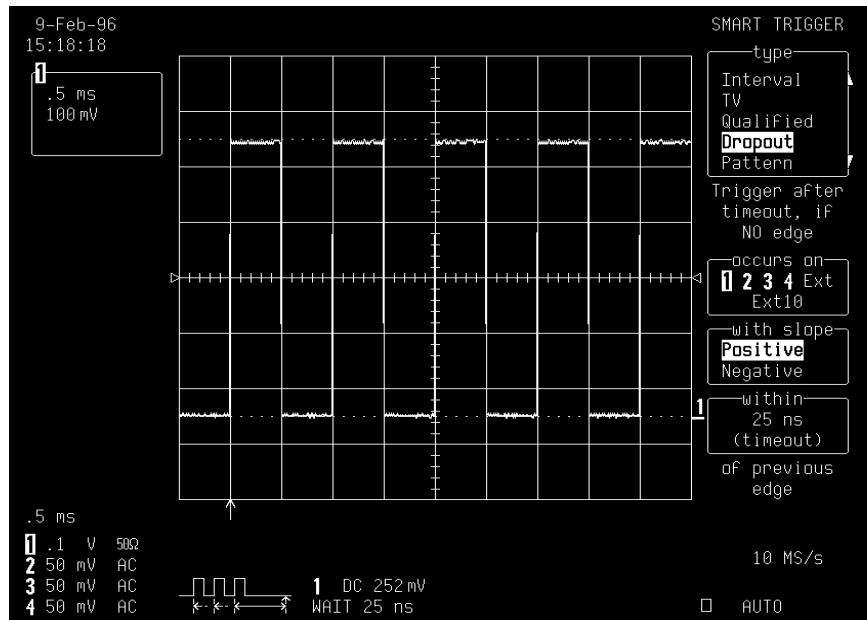

STEP 6 

Press  to activate the trigger.

Tips: The Dropout Trigger must be set (in descending order) on the SMART TRIGGER menus as follows:

Trigger after timeout, if NO edge
within (timeout)
of previous edge.

In order to capture the squarewave when it disappears, the timeout must be longer than the signal period. There is no triggering when the repetitive signal is active, because two successive edges occur in a single period — 1 ms in this example.



Measuring Skills

STEP 7

Turn the upper 'menu'  to set the timeout. For this example, the timeout must be greater than 1 ms.

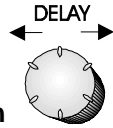

Now turn  to set the trigger point to just left of mid-screen and allow the display of the signal's 'last normal' period.

The screen will now display:

Note: As shown here, the scope will no longer trigger until after the signal disappears.

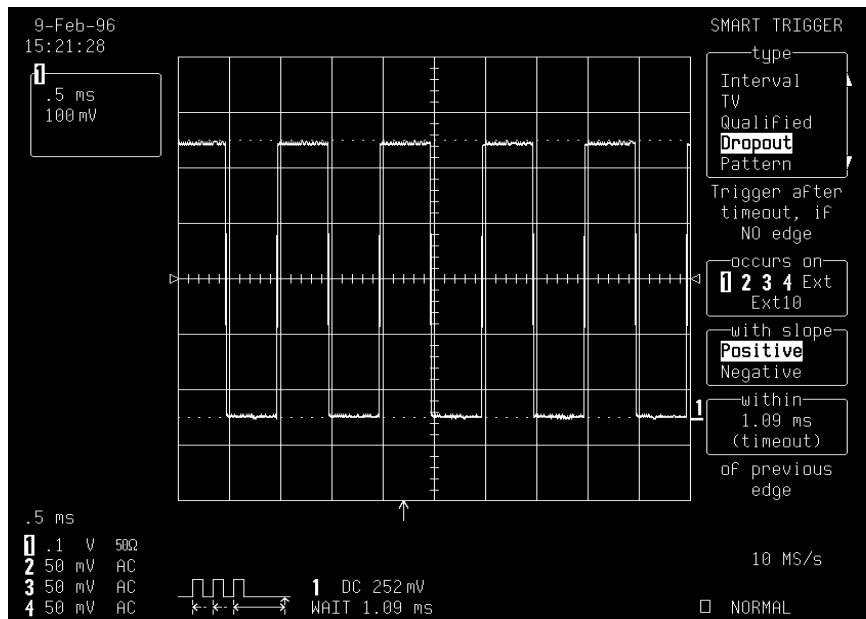

Lost Signals (Dropout Trigger)

Once the signal has disappeared, the acquisition is performed. The last screen displays the 'last normal' period and the transient signal.

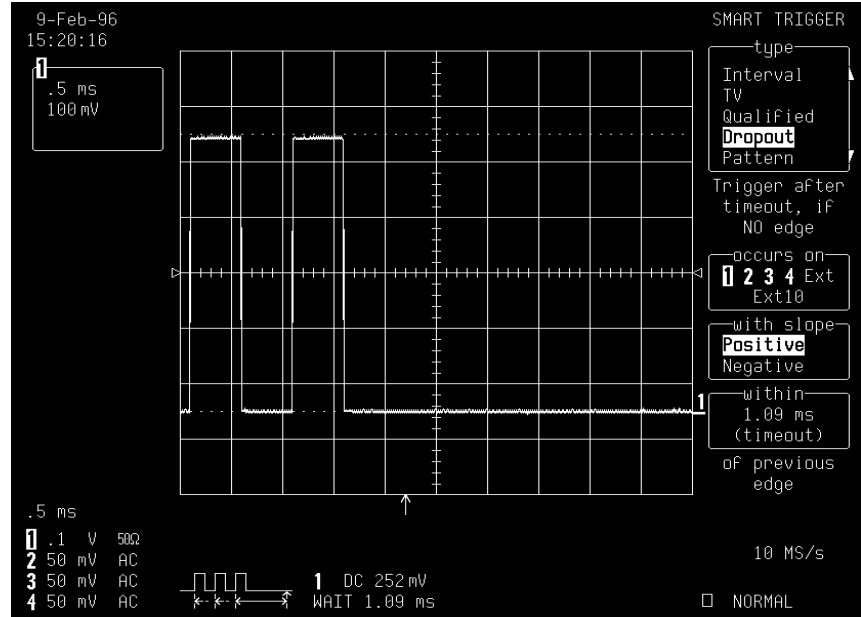



Transferring Data to PC

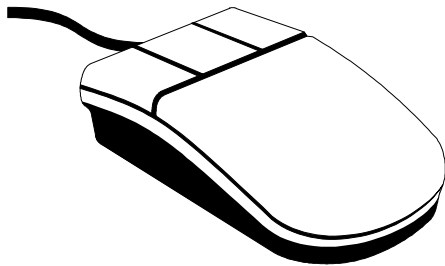

Transfer to PC of real acquired waveform data is clearly practical when calculating or storing data using common spreadsheet or math software. Here's how to do this in three ways, using GPIB, floppy or RS232 communication port.

The scope can directly store to floppy in the ASCII format traces of up to 50 000 points; larger waveforms can be stored to removable hard disk or PC memory card (*see the **Operator's Manual***). However, for the larger traces, a conversion from the LeCroy binary format to ASCII* will be needed. How to do this is also explained here (*page 3-157*).

* The scope stores data in LeCroy's binary format, conversion of which to ASCII creates an output file requiring 10-20 times the disk space of the original LeCroy binary file. A one-megabyte record will typically take up 13-15 MB stored in ASCII. And waveforms stored in ASCII cannot then be recalled back into the scope.

Transfer by GPIB

Wherever the  icon is shown, the action concerned is to be performed on the PC. All other actions relate to the oscilloscope controls.

Hardware Required

PC equipped with GPIB (General Purpose Interface Bus) card.

Software Required

gtalk.exe and gt.bat software — free from LeCroy (*Contact your nearest sales office*).

Application Setup

Connect the signal to be acquired to CH 1.

STEP 1

Press 

Then press the  for “GPIB/RS232 Setup”.

And the  to select “**GPIB**”, if not already selected (normally by default), from the “Remote” menu.



The screen will display:

Note: The scope's address GPIB must be "4". This allows remote control by GPIB commands (see the Remote Control Manual).

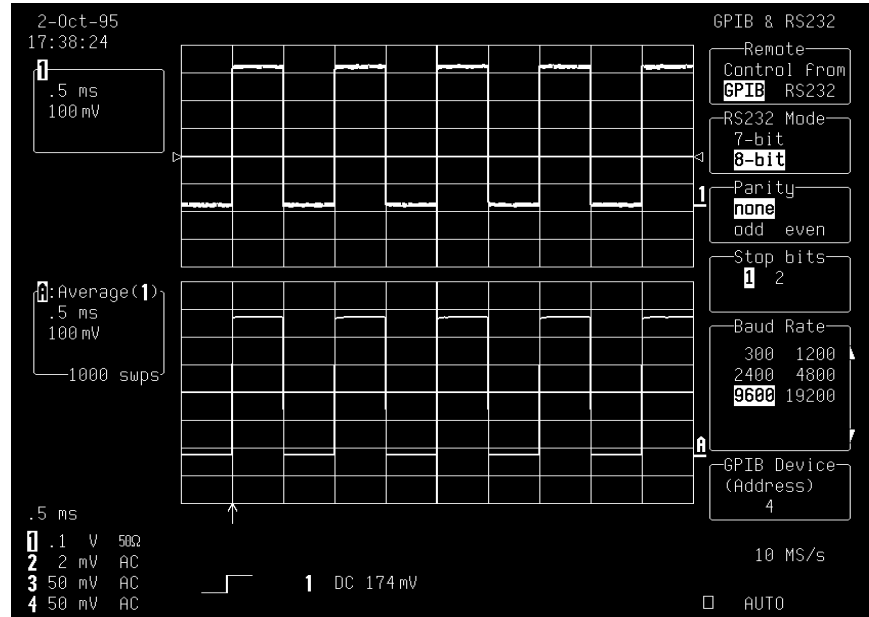



Auto-read (Alt D) must also be disabled in GTALK.

Now, with the acquisition performed...

Type in the command "gt" at the DOS prompt.

This will run the GTALK program on the PC.

STEP 2 

 Type in the command “C1:WF?” (for the complete list of WAVEFORM command descriptions, see the **Remote Control Manual**).

STEP 3 

 Press Alt F to select the output linking the PC to the scope.

STEP 4 

 Give the output file a name.

Note: The PC window will display the number of bytes transferred. By default, each point is defined by a word (two bytes). Added to the total of transferred bytes are those of the descriptor, which gives all the oscilloscope setup details.

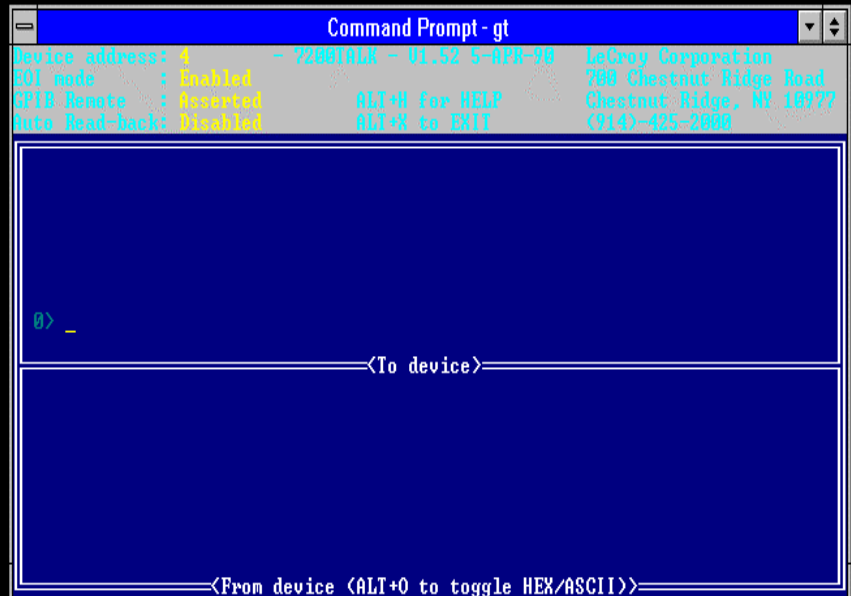

```
Command Prompt - gt
device address: 4          -- 7200TALK -- 01.52 5 APR 98  LeCroy Corporation
ROI mode       : Enabled   700 Chestnut Ridge Road
GPIB Remote    : Asserted  Chestnut Ridge, NY 10977
Auto Read-back: Disabled   (914) 425-2888
                  ALT+F for HELP
                  ALT+X to EXIT

0> _

<To device>

<From device <ALT+O to toggle HEX/ASCII>
```

“GTALK” PC program window

STEP 5 

 Press Alt X to exit.

 **Tips:** To transfer data direct in ASCII, instead of Step 2 above, type the command “C1:INSP? ‘Data_array_1’”. The file will take up 10–20 times the disk space of a binary file.



Transfer to Floppy

STEP 1 

Press  to store data in a source file (format: Name.000 or .001 or .002 — given by the oscilloscope).

STEP 2 

Press the  to select “**Flopy**” from the “to” menu and display:

Note: A message will appear at the top of the scope screen announcing the successful storage of the data and giving the name of the file on which the data is stored on the floppy.

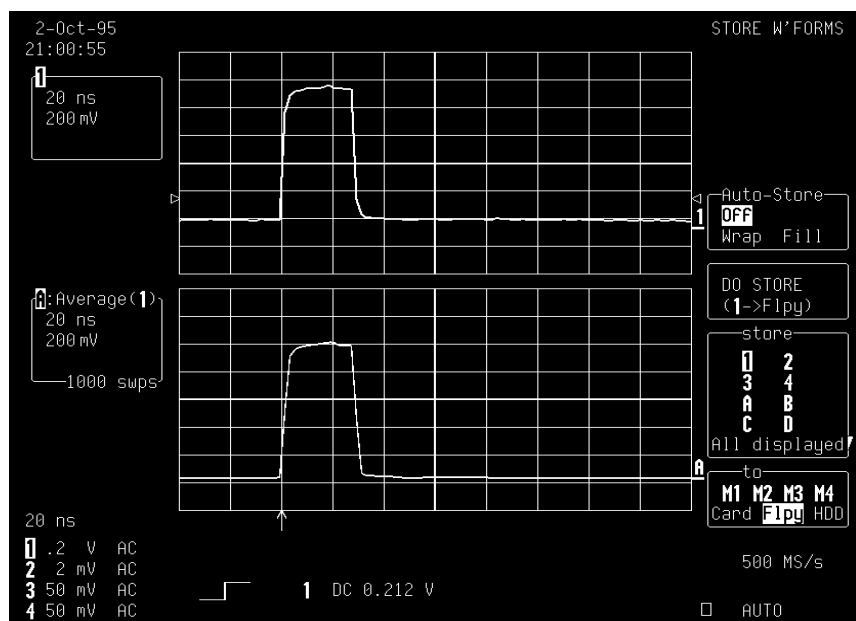

STEP 3 

Press the  for “DO STORE”.

STEP 4 

Eject the floppy from the scope and place it in the PC to complete the transfer.

Transfer by RS232

Hardware Required

PC with RS232 communication port.

Software Required

LCRS232.exe — free from LeCroy (*Contact your nearest sales office*).

Application Setup

Connect the signal to be acquired to CH 1.

Press **UTILITIES** then press the respective **RS232** for “**GPIB/RS232 Setup**” and to select “**RS232**” from the “**Remote**” menu.

The screen will display:

Note: Check that the scope's RS232 setup and connections (see Remote Control Manual). PC default values are valid.

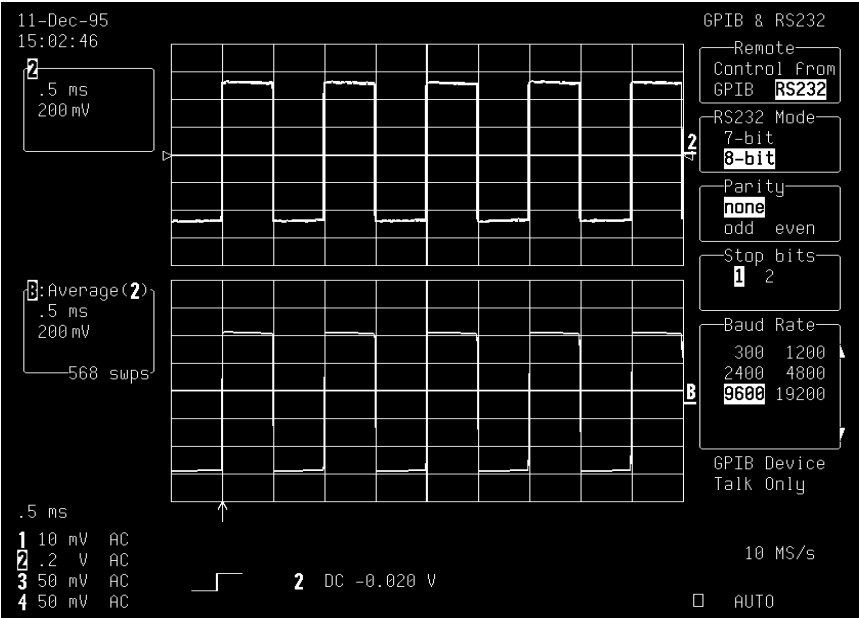



Measuring Skills

STEP 1

Type "LCRS232.exe" in response to the DOS prompt to run the program LCRS232.

This program allows remote control of the oscilloscope by typing in commands (see *Remote Control Manual* for the full command list) in response to prompts such as "Your Choice :".

STEP 2

Type in "Your Choice : S" — to store a waveform.

STEP 3

Type in "Channel : C1" — if the waveform is on CH 1.

STEP 4

Using — for example — *Isis* as a file name:

Type in "Filename : Isis" — to name the stored binary data file.

STEP 5

Press Alt X to exit.

RS-232 nine-pin communication cabling for PC.

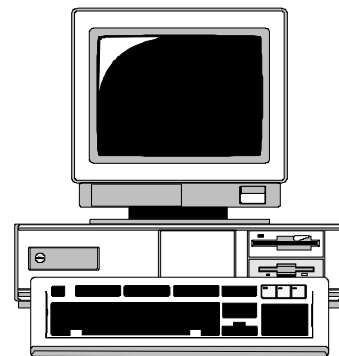
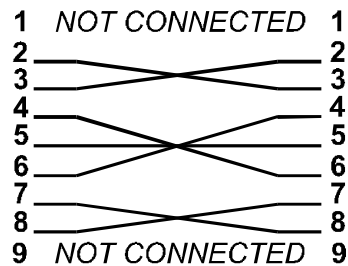
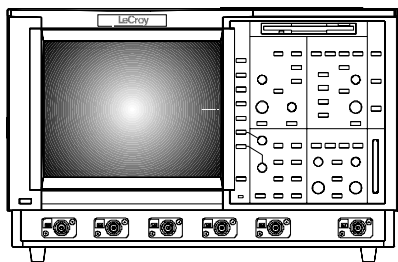

Converting Binary to ASCII

Hardware required

PC

Software required

Wavetran.exe and 93xx.tpl software — free from LeCroy (*Contact your nearest sales office*).

STEP 1 

To run the Wavetran program, converting binary data from an oscilloscope binary source file named *Isis* to a PC ASCII output file named — for example — *Osiris*:

 **Type “Wavetran -oOsiris Isis”** (“Wavetran -oOutputfilename Sourcefilename”) at the DOS prompt.

The binary-format file from the oscilloscope can now be read in ASCII by common PC software programs.

STEP 2 

 **Open the file converted to ASCII with the application of choice.**

 **Tips:** *Help for Wavetran is available by typing “Wavetran”. Conversion of data from the LeCroy binary format to ASCII format creates an output file that requires 10–20 times the disk space of the original LeCroy binary file. A one-megabyte record will typically take up 13–15 MB when stored in ASCII. Program Wavetran may run for some minutes when executed for long waveforms of several kB.*



Transferring Images to PC

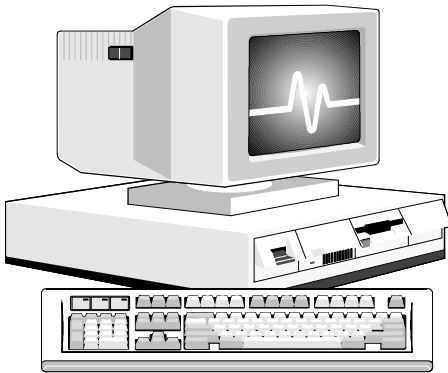

The images are TIFFs (Tagged Image File Format) and BMPs (Bitmaps) that replicate what is shown on the oscilloscope screen.

It's extremely handy to transfer them to PC so that they can be incorporated into work done using common PC software — a report, for example.

The following tutorial shows how to do this with TIFF, condensed TIFF or BMP images, by means of GPIB (General Purpose Interface Bus), floppy or RS232 communication port.

Transfer by GPIB

Hardware Required

Personal computer equipped with GPIB card.

Software Required

gtalk.exe and gt.bat software — free from LeCroy.

Application Setup

The screen to be saved having already been set up...

Press 

Then press the corresponding s: first, for “Hardcopy Setup”; second, to select “**GPIB**” from the “output to” menu; and third, to select from “TIFF”, “TIFF compr.” (compressed TIFF) and “BMP” in the “protocol” menu.

Select “**TIFF**”. The screen will display:

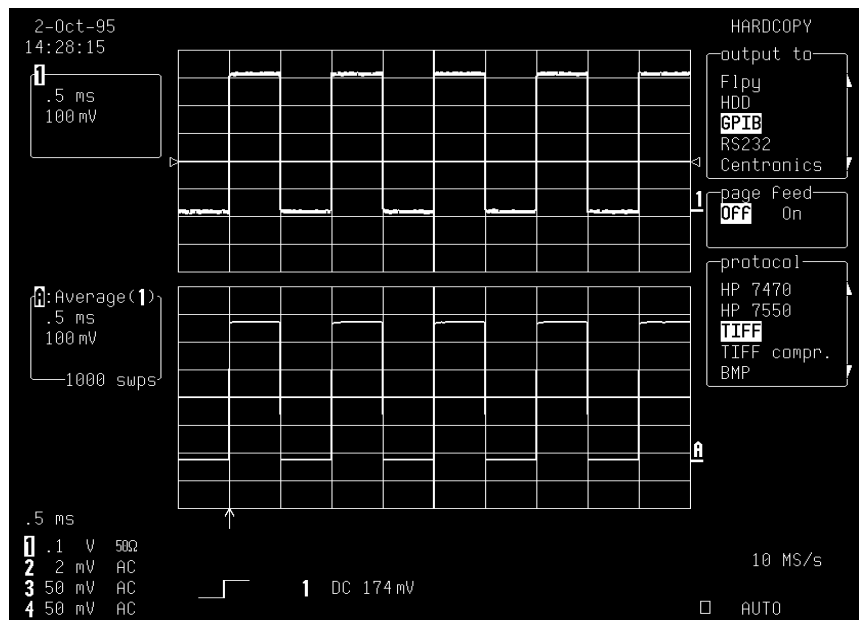

Press  again.



Measuring Skills

Then — as described in the directions for data transfer in the previous chapter...

Press the s for “GPIB/RS232 Setup”, and to select “**GPIB**”, if not already selected (normally by default), from the “Remote” menu.

The screen will display:

Note: The scope's address GPIB must be “4”. This allows remote control by GPIB (see Remote Control Manual). Auto-read (Alt D) must also be disabled.

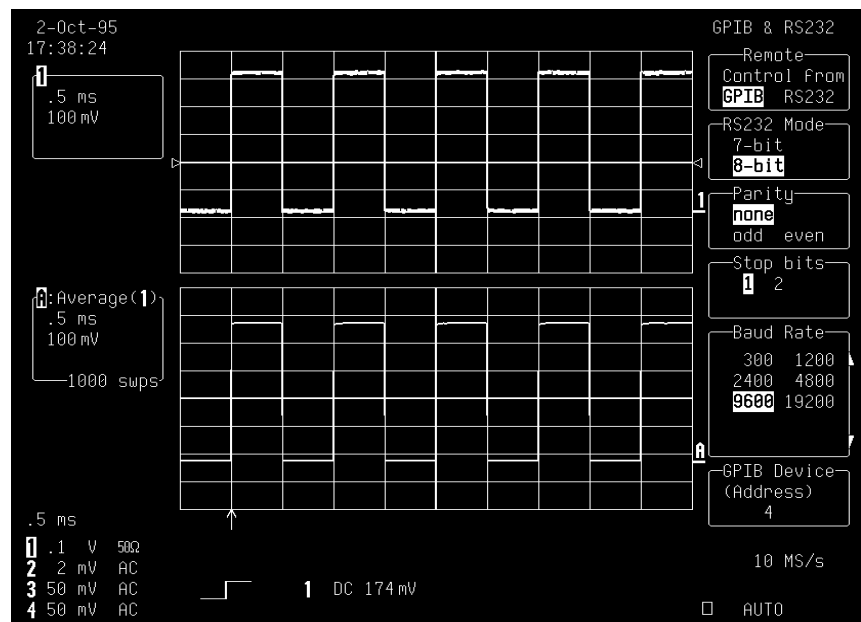



STEP 1

 With the acquisition performed: Type “gt” at the DOS prompt. This will run the GTALK program on the PC.

Images to PC

STEP 2 

 Press **Alt L** to control the scope in **Local Mode**, which allows a screen dump with a selected menu, but without the message “Go to Local”.

STEP 3 

 Type the command “**SCDP**”

STEP 4 

 Press **Alt F** to select the output linking the PC to the scope.

STEP 5 

 Give a name to the screen dump file.

Note: If the size of the TIFF is not exactly 308 949 bytes, the file will be corrupted. The GPIB setup will then need to be verified and the transfer redone.

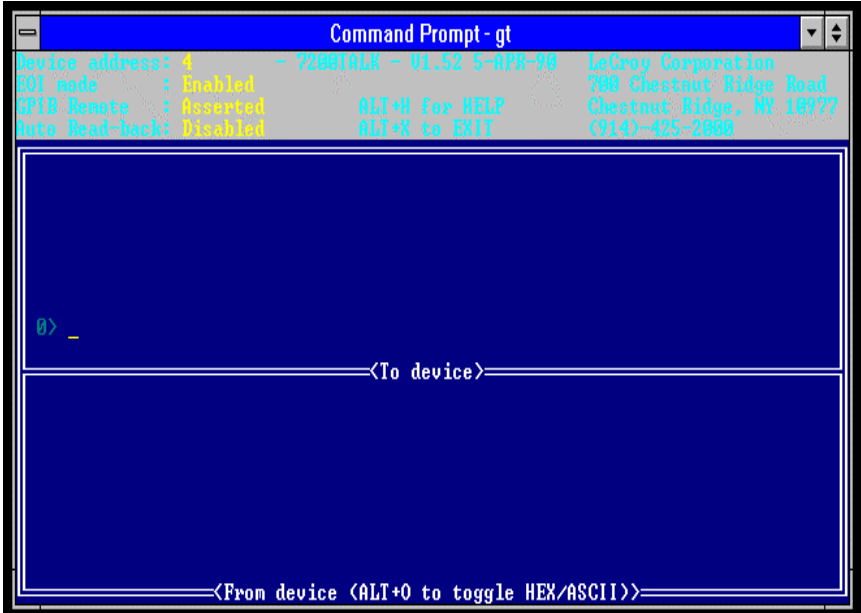

```
Command Prompt - gt
Device address: 4      - 7200TALK - 01.52 5-APR-98  LeCroy Corporation
EOT mode      : Enabled                               700 Chestnut Ridge Road
GPIB Remote   : Asserted                             Chestnut Ridge, NY 10977
Auto Read-back: Disabled                             (914) 425-2800

0> _
<To device>
<From device <ALT+0 to toggle HEX/ASCII>
```

“GTALK” PC window

STEP 6 

 Press **Alt X** to exit.



Transfer to Floppy

Application Setup

The screen to be saved having already been set up...

Press **UTILITIES**, then the corresponding **Floppy**s: first, for “Hardcopy Setup”; second, to select “**Flopy**” from the “output to” menu; and third, to select a file format — “**TIFF**”, “**TIFF compr.**” or “**BMP**” — from the “protocol” menu.

The screen will display:

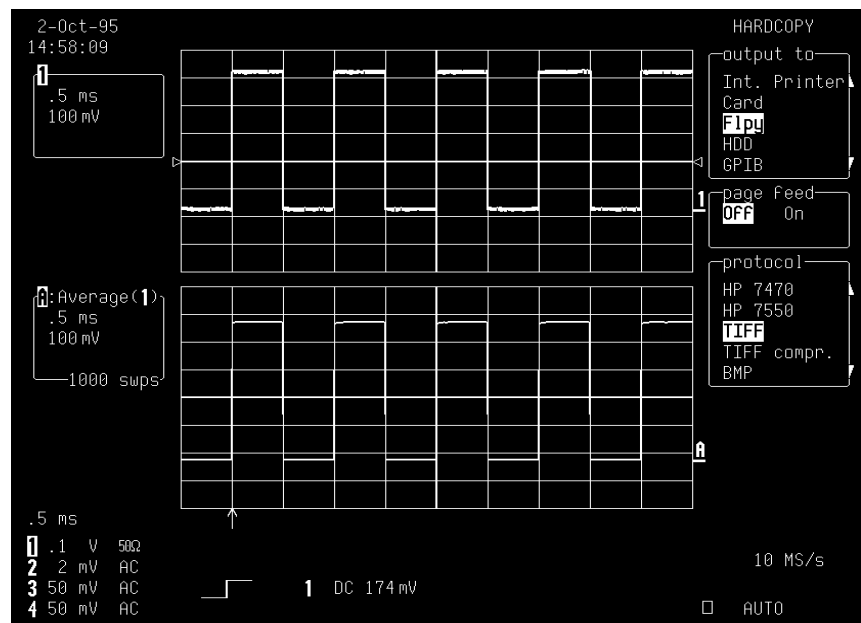

Transfer to Floppy (cont.) *Once the screen image to be transferred is ready...*

STEP 1 

Press  to store data in a source file on the floppy (format: Name.000 or .001 or .002, given by the oscilloscope).

STEP 2 

Eject the floppy from the scope and place it in the PC. The TIFF or BMP can now be directly imported into files run on common software that recognizes its file format.

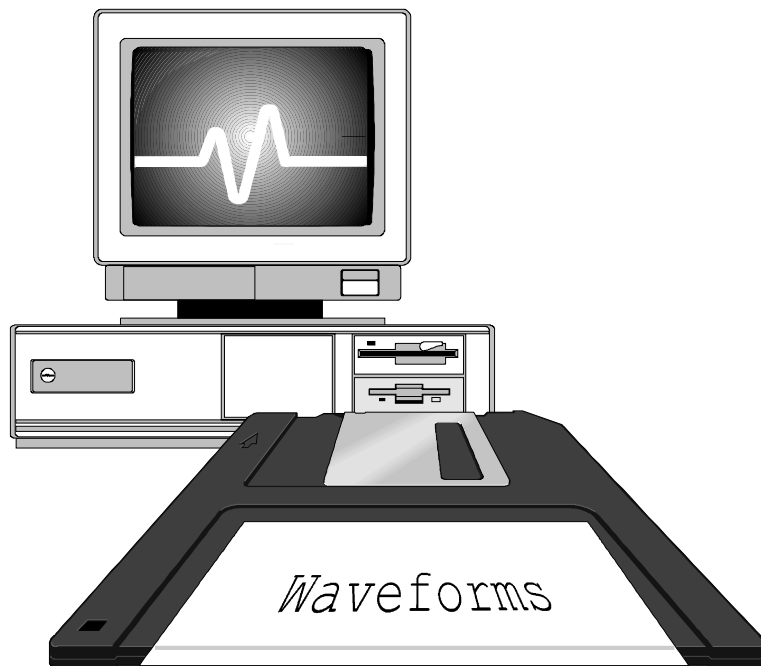

STEP 1

Note: Check the scope's RS232 setup and connections (see Remote Control Manual), and that PC default values are valid.

Type “LCRS232.exe” in response to the DOS prompt to run the program LCRS232. This program allows remote control of the oscilloscope by typing in commands (see *Remote Control Manual* for the full command list) in response to prompts such as “Comment :”.

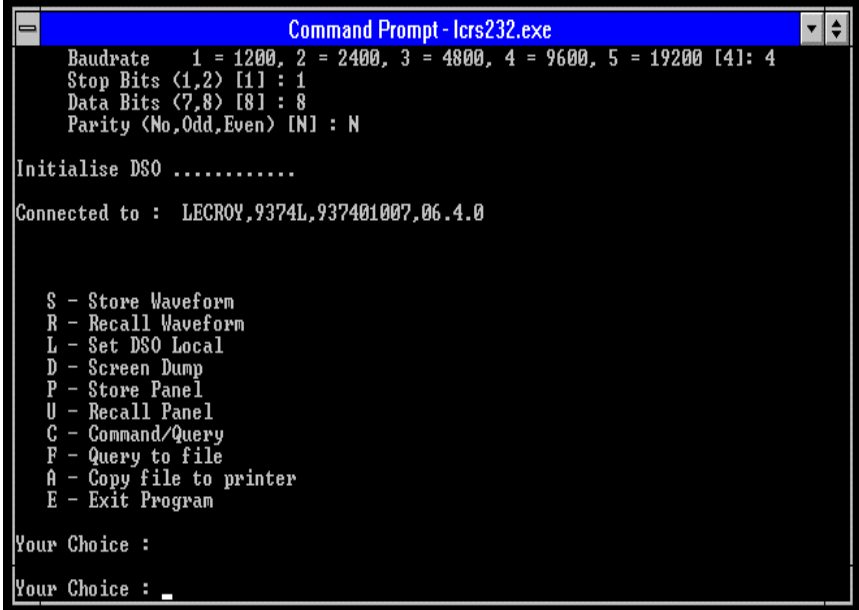

```
Command Prompt - lcrs232.exe
Baudrate 1 = 1200, 2 = 2400, 3 = 4800, 4 = 9600, 5 = 19200 [4]: 4
Stop Bits (1,2) [1]: 1
Data Bits (7,8) [8]: 8
Parity (No,Odd,Even) [N]: N

Initialise DSO .....
Connected to : LECROY,9374L,937401007,06.4.0

S - Store Waveform
R - Recall Waveform
L - Set DSO Local
D - Screen Dump
P - Store Panel
U - Recall Panel
C - Command/Query
F - Query to file
A - Copy file to printer
E - Exit Program

Your Choice :
Your Choice : _
```

“LCRS232” program window

STEP 2

Type in “Your choice : D” — to send the image file to the PC.

STEP 3

Type in “Comment : “text” — if a comment is desired to be placed on the TIFF image, above the grid. A name or title could be inserted, such as “Comment : For Isis Report”.

STEP 4

Again, using *Isis* as an example name: Type in “Filename : Isis” — to name the stored TIFF file.

STEP 5

Press Alt X to exit. 



First-Hand Experience

Having completed the guide, you will be well-briefed in the efficient operation of your oscilloscope. And this first-hand experience should make all your measurements easier.

The guide can continue to serve as a practical reference to turn to as required. Use it together with the accompanying *Operator's Manual*, keeping both close at hand.

We wish you excellent measuring!



A

absolute amplitude
mode, 3–18
absolute time mode, 3–20
acquisition memory system,
1–2
ADC. See analog-to-digital
converter
aliasing. See interpolation
amplifier, 1–2
ANALOG PERSIST button,
3–33
Analog Persistence, 3–31
analog-to-digital converter
(ADC), 1–2, 1–6, 3–6
analyzing, 1–4, 1–9–1–10
AUTO SETUP button, 2–2, 2–7
in first steps common to
most measurements, 3–2,
3–4, 3–6, 3–10, 3–16,
3–17, 3–26, 3–31, 3–39,
3–54, 3–63, 3–70, 3–87,
3–97, 3–115, 3–127,
3–135, 3–144
Auto-Store
'Fill', 3–113
'Wrap', 3–113
Average
used to remove noise, 3–26–
3–30
averaging traces, 3–29

B

bandwidth, 1–3
bitmap (BMP)
transfer to PC. See data
transfer of images
buttons
non-use during sequence
acquisition, 3–62

C

capturing, 1–4, 1–5–1–7, 1–6

channel input sensitivity
adjusting, 3–7
CLEAR SWEEPS button,
3–15, 3–29
for setting or clearing
persistence, 3–35
Color, 3–39
choosing color schemes,
3–47, 3–48
Color Graded Persistence,
3–38
communication port RS232,
3–158
controls
front-panel main controls.
See front-panel controls
coupling, 3–3, 3–130
four-channel models, 3–3
COUPLING button
in first steps common to
most measurements, 3–3,
3–6, 3–10, 3–17, 3–26,
3–31, 3–39, 3–54, 3–63,
3–71, 3–88, 3–97, 3–115,
3–127, 3–135, 3–144
cursors, 2–14
absolute time, 3–22
accurate measuring with,
3–16–3–25
cursor knobs. See moving
cursors under cursors
in telecom mask testing,
3–104
moving cursors, 2–14, 2–15,
3–13, 3–18, 3–23
reference and difference,
3–24
CURSORS/MEASURE button,
2–14, 2–21, 3–11
in telecom mask testing,
3–103
custom mode, 3–15
custom parameter mode
parameters and histograms,
3–82, 3–83



D

- data transfer, 1–4
 - data to PC, 3–150–3–157
 - images (TIFFs, BMPs) to PC, 3–158–3–165
- deadtime
 - reducing it using sequence mode, 3–53–3–62
- default power-up settings, 3–2
- DELAY knob, 2–11
 - to set trigger point, 3–148
- digitizing, 3–6
 - on all eight bits, 3–6
- display, 1–4
- DISPLAY button, 2–12, 3–32, 3–42, 3–117
- documenting, 1–4, 1–10–1–11
- dropout trigger (SMART)
 - on lost signals, 3–144–3–149
- DSO (Digital Signal Oscilloscope), 1–1–1–11
 - advantages, 3–9
 - basic elements, 1–2
- dual display mode, 3–92

E

- edge trigger (SMART), 3–129, 3–137, 3–146
- eight-bit digitizing, 3–6–3–8
- Enhanced Resolution option, 3–123
- exclusion trigger (SMART), 3–138
- EYE-diagram analysis, 1–10

F

- Fast Fourier Transform (FFT)
 - WP02 FFT option. See spectrum analyzer, frequency domain analysis

- FFT, 1–9, 2–20, 2–21. See Fast Fourier Transform
- first steps common to most measurements, 3–1–3–5
- Floppy disk, 3–162
- Floppy disk, 3–154
- frequency domain analysis, 1–9, 3–63–3–69
- frequency resolution
 - to increase, 3–68
- front-panel controls, 2–1, 2–5
 - AUTO SETUP, 2–2, 2–7
 - CHANNELS, 2–2, 2–8
 - TIMEBASE + TRIGGER, 2–2
 - TIMEBASE controls, 2–9
 - TRIGGER controls, 2–11
 - vertical controls, 2–10
 - ZOOM + MATH, 2–2
- FULL SCREEN button, 3–45

G

- glitches, 1–5
 - capture, 3–127–3–134
- GPIB (General Purpose Interface Bus), 3–151, 3–158, 3–162
- GTALK. See data transfer to PC

H

hard disk drive
removable, 3-109-3-113
HDD. See hard disk drive
histograms, 1-9, 3-75-3-86

I

initialization, 2-4
installation, 2-4
interfaces, 1-11
interpolation, 3-87-3-95
slow timebase acquisitions,
3-94
interval trigger (SMART),
3-138

K

knobs
non-use during sequence
acquisition, 3-62

L

local mode
in transfer of images to PC,
3-161
long memory option. See long
waveforms
long waveforms, 3-114-3-126
lost signals. See dropout
trigger (SMART)

M

mask comparison, 1-10
MATH SETUP button, 2-17,
2-20, 3-65
for boosting Math functions,
3-66
for long-waveform
acquisition, 3-118
to display recalled telecom
masks, 3-99
Measuring, 1-8
memory length, 1-4

menu box, 2-5, 2-10, 2-17
menus
'Action', 3-107
'at end of', 3-138
'Auto-Store', 3-113
'Avg Type', 2-19
'Avg Type' (averaging type),
3-29
'Category', 3-76, 3-83
'CHANGE COLORS', 3-49
'Change Test', 3-107
'Color Scheme', 3-47
'Coupling', 3-3, 3-6, 3-10,
3-17, 3-26, 3-31, 3-39,
3-54, 3-63, 3-71, 3-88,
3-97, 3-115, 3-127,
3-135, 3-144
'DISPLAY SETUP', 3-33,
3-42
'Dot Join', 3-89
'for Math use', 3-100, 3-118
'FROM DEFAULT SETUP', 2-
5
from Memory', 2-22
'Grids', 2-12, 3-27, 3-64,
3-92, 3-117
'if', 3-107
'mask', 3-105
'Math Type', 2-19, 3-29,
3-66, 3-73, 3-91, 3-123
'measure', 3-76
'mode', 2-16, 3-12, 3-18,
3-20, 3-82
'More Display Setup', 3-47
'of', 3-83, 3-105
'On line', 3-83
'output', 3-162
'output to', 3-159
'Persist', 3-35
'Persistence', 3-33, 3-34
'Persistence Setup', 3-34
'protocol', 3-159, 3-162
'Record up to', 3-68, 3-115
'Reference', 3-20
'Remote', 3-151, 3-160
'Sequence', 3-57
software options displayed,
3-73



- 'statistics', 2–16, 3–14
- 'Stop', 3–107
- 'Test on', 3–104
- 'testing', 3–104
- 'Text & Times', 3–60
- 'Then', 3–107
- TIMEBASE, 3–115–3–116
- 'TIMEBASE', 3–41
- 'to', 3–14, 3–154
- 'trigger on', 3–138
- 'type', 2–21, 3–18, 3–22, 3–146
- 'use Math?', 3–65, 3–72, 3–91, 3–122
- 'using up to', 3–81
- 'width', 3–132, 3–138

N

- noise
 - using Average to remove it. See Average
- NORM button, 2–21
 - to run telecom mask test, 3–105
 - to start SMART trigger, 3–132, 3–140, 3–147
- Nyquist limit (aliasing). See interpolation

O

- OFFSET knob, 2–23
- Options
 - WP01, WP02, WP03, Enhanced Resolution, 3–123

P

- PANEL SETUPS button, 2–4, 2–23
- parameter statistics
 - in capture of rare phenomena, 3–141

- parameters, 2–16
 - automatic measurement of, 3–9
 - categories of. See menus, 'Category'
 - in telecom mask testing, 3–103
 - menu. See menus
 - read by remote control, 3–15
 - standard. See standard parameters
 - statistical analysis. See histograms
 - values, 3–14
 - vertical. See vertical parameters
 - with histograms, 3–75–3–86
- Partial Response Maximum Likelihood (PRML), 1–10
- Pass/Fail function, 1–6, 1–10.
 - See telecom mask testing with exclusion trigger, 3–141
- peak detect system, 1–5
- persistence
 - in capture of rare phenomena, 3–141
 - showing edge jitter, 3–72
- persistence mode
 - display in glitch capture, 3–133
- phenomena
 - analysis of difficult-to-measure phenomena. See histograms
 - rare. See SMART trigger
- POSITION knob, 2–13
- POSITION knobs
 - in long-waveform acquisition, 3–120
- Power On
 - Self-Test, 2–4
- processor, 1–2
- pulse parameters, 1–8

Q

quantification, 3–7
quantization
 on all levels, 3–6

R

RAM (Random Access Memory), 3–114
Random Access Memory. See RAM
Random Interleaved Sampling (RIS), 1–5
RECALL button, 2–22
relative amplitude mode, 3–19, 3–20
relative time mode, 3–22
removable hard disk drive. See hard disk drive
reset
 in first steps common to most measurements, 3–2
RESET button, 3–121
 for ZOOM + MATH, 3–2
 with histograms, 3–79
roll mode, 1–5
RS232 communication
 cabling, 3–156
RS232 communication port, 3–155, 3–164

S

sample rate, 1–4
sequence acquisition, 3–53–3–62
sequence mode, 1–6, 3–53–3–62
 for determining acquisition duration, 3–58
 setting timebase, 3–59
Setup Save and Recall, 2–23
SHOW STATUS button, 3–124
 in long-waveform acquisition, 3–121
Sin(x)/x interpolation. See interpolation

SINGLE button, 2–20
single-shot acquisition, 1–5
slow timebase
 acquisition using interpolation, 3–94
SMART trigger, 1–6, 3–135–3–143. See edge, dropout, interval triggers
 in glitch capture, 3–130–3–131
SNGL button
 for long-waveform acquisition, 3–116
 for storing to hard disk, 3–110
 to stop acquisition, 3–115
 used to stop scope, 3–17
source
 selection, 3–129
spectrum analyzer
 using the scope as, 3–63–3–69
standard parameters
 voltage, 3–9
statistical domain, 1–9
STOP button, 3–11, 3–136
STORE button
 for storing to hard disk, 3–110
storing to removable hard disk. See hard disk drive
summed averaging, 2–17
sweeps, 3–29, 3–30
system memory, 1–2

T

telecom mask testing, 3–96–3–108
test masks. See telecom mask testing
threshold position, 2–11
TIFFs
 transfer to PC, 3–158
time domain, 1–9
TIME/DIV knob, 2–9
 used to slow down timebase, 3–116



TIMEBASE + TRIGGER, 2-2
TIMEBASE SETUP button,
3-115
for display of no. points, time
between pts., and
sampling rate, 3-89
trace labels, 2-7, 2-10
TRACE ON/OFF button, 2-8,
2-10, 2-13, 2-17, 3-2
for display of multiple traces
and grids, 3-93
traces, 3-2
train pulses, 3-55
trigger position, 2-11
TRIGGER SETUP button,
3-136
glitch capture, 3-128
on lost signals, 3-145
triggering, 1-6

U

use Math menu, 2-19
UTILITIES button, 3-159

V

VAR button, 2-2, 2-10, 3-7

vertical parameters, 3-12
viewing, 1-4, 1-7
VOLTS/DIV knob, 2-10, 2-23

W

waveform math, 1-8
waveform memories, 2-21
WAVEFORM STORE button,
2-22
WP01 waveform processing,
3-123
WP02 FFT, 3-123
WP03 waveform processing,
3-123. See histograms

X

XY mode
persistence, 3-34

Z

ZOOM, 2-12
ZOOM knobs, 2-13
in long-waveform
acquisition, 3-120
